

EN Operating and installation instructions X Pure, Pure

X Pure surface induction cooktop with integrated cooktop extractor – exhaust air/recirculation (PUXA/PUXU)

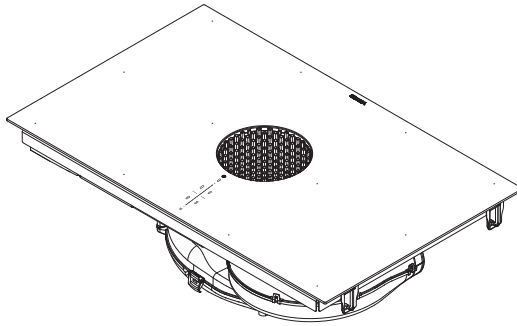

Pure induction cooktop with integrated cooktop extractor – exhaust air/recirculation (PURA/PURU)

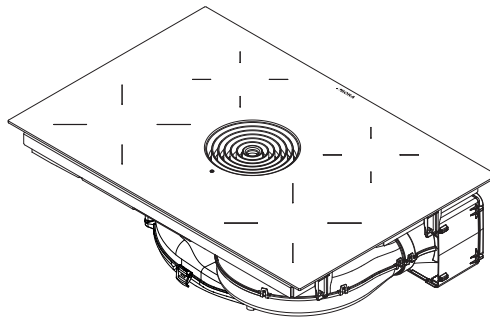

003292-10004

Table of Contents

1	General information	84	6.5.4	Automatic extractor function	110
1.1	Liability	84	6.5.5	Automatic after-run	110
1.2	Validity of the operating and installation instructions	84	6.5.6	Filter service display.....	110
1.3	Product conformity.....	84	6.6	Operating the cooktop.....	110
1.4	Presentation of information.....	84	6.6.1	Pan size recognition	110
2	Safety	86	6.6.2	Permanent pan size recognition.....	111
2.1	Intended use	86	6.6.3	Switching the cooking zone on/off.....	111
2.2	People with limited abilities.....	86	6.6.4	Setting cooking zone power levels.....	111
2.3	General safety instructions.....	87	6.6.5	Cooking zone power setting.....	112
2.4	Safety information for installation	89	6.6.6	Automatic heat up function.....	112
2.5	Safety instructions – operation.....	91	6.6.7	Cooking zone timer	112
2.6	Safety instructions – cleaning and maintenance	95	6.6.8	Pause function.....	113
2.7	Safety instructions – repairs, servicing and spare parts	96	6.6.9	Heat retention function (only on Pure).....	114
2.8	Safety instructions – disassembly and disposal	96	6.6.10	Variable heat retention function (only on X Pure).....	114
3	Technical data	98	6.6.11	Bridging function (only on X Pure).....	115
3.1	X Pure (PUXA, PUXU)	98	6.6.12	Automatic bridging function (only on X Pure).....	115
3.2	Pure (PURA, PURU).....	99	6.7	Safety features.....	115
4	Energy labelling	101	6.7.1	Child lock.....	115
5	Appliance description	102	6.7.2	Residual heat indicator.....	115
5.1	Model description.....	102	6.7.3	Safety shut-down.....	116
5.2	System description.....	102	6.7.4	Overheating protection.....	116
5.2.1	Structure	102	7	User menu	117
5.2.2	Operating panel.....	102	7.1	Menu item 1: Volume of the acoustic signals	118
5.2.3	Symbols.....	104	7.2	Menu item 2: Childproofing feature.....	118
5.2.4	7-segment display	104	7.3	Menu item 3: Showing the filter status and resetting filter service display.....	119
5.2.5	Lighting.....	104	7.4	Menu item 4: Duration of the automatic after-run function.....	119
5.2.6	Sounds	105	7.5	Menu item 5: Touch zone reaction speed	120
5.3	How the cooktop extractor works.....	105	7.6	Menu item 6: LED test	120
5.4	How the induction cooktop works	105	7.7	Menu item 7: Permanent pan size recognition	121
5.4.1	Suitable cookware.....	105	7.8	Menu item 8: Show software/hardware version	121
5.4.2	Noises.....	106	7.9	Menu item 9: Safety shut-down	122
6	Functions and operation	107	7.10	Menu item A: super simple mode	122
6.1	General operating instructions.....	107	7.11	Menu item 0: Reset to factory settings...	123
6.2	Touch control	107	8	Cleaning and maintenance	124
6.3	Function overview	107	8.1	Cleaning agents	124
6.4	Operating the system.....	108	8.2	Cooktop and extractor care.....	124
6.4.1	Switching the appliance on and off.....	108	8.3	Cleaning the cooktop	124
6.4.2	Short-time timer (egg timer)	108	8.4	Cleaning the cooktop extractor.....	125
6.4.3	Control lock.....	109	8.4.1	Removing the components	125
6.4.4	Cleaning lock.....	109			
6.5	Operating the cooktop extractor.....	109			
6.5.1	Switching the fan on and off.....	109			
6.5.2	Setting the fan power level	109			
6.5.3	Fan power setting.....	109			

8.4.2	Cleaning the air inlet nozzle and stainless steel grease filter	126	10.7.8	Extending the telescopic pull-out of the air cleaning box (PULBTA)	144
8.4.3	Fitting the components	126	10.7.9	Inserting the cooktop	145
8.4.4	Removing liquids from the appliance	126	10.7.10	Securing the cooktop	146
8.5	Cleaning the air guiding housing.....	127	10.7.11	Making a connection with the back panel (only in installation variant A).....	146
8.6	Replacing the activated charcoal filter	127	10.7.12	Inserting the activated charcoal filter	146
9	Troubleshooting	130	10.8	Connecting the power supply.....	147
10	Installation	132	10.9	Initial operation.....	149
10.1	General installation instructions	132	10.9.1	Dealer and service menu	149
10.1.1	Simultaneous operation of the cooktop extractor in the exhaust air mode and a fireplace dependent upon the air supply in the room.....	132	10.9.2	Function test	151
10.1.2	Home In module PUHIM (optional)	133	10.10	Sealing the appliance	151
10.2	Scope of delivery	133	10.11	Handover to user.....	151
10.3	Tools and aids	133	11	Decommissioning, disassembly and disposal	152
10.4	Assembly instructions.....	133	11.1	Decommissioning	152
10.4.1	Installation clearances	133	11.2	Disassembly	152
10.4.2	Minimum unit dimensions for X Pure (PUXA, PUXU)	134	11.3	Environmentally-friendly disposal	152
10.4.3	Minimum unit dimensions for Pure (PURA, PURU).....	134	12	Warranty, technical service, spare parts, accessories	153
10.5	Worktop cut-out.....	134	12.1	BORA manufacturer's warranty.....	153
10.5.1	X Pure cut-out dimensions (PUXA, PUXU) .	135	12.1.1	Warranty extension	154
10.5.2	Pure cut-out dimensions (PURA, PURU)	135	12.2	Service.....	154
10.6	Installing the appliance in exhaust air mode (PUXA, PURA)	136	12.3	Spare parts.....	154
10.6.1	Preparing kitchen units for the exhaust air model.....	136	12.4	Accessories	154
10.6.2	Installation dimensions	137			
10.6.3	Preparing the cooktop.....	137			
10.6.4	Inserting the cooktop	138			
10.6.5	Securing the cooktop	139			
10.6.6	Connecting the appliance to the duct system	139			
10.7	Installing the recirculation model (PUXU, PURU) of the appliance.....	139			
10.7.1	Recirculation of air from the kitchen unit ..	139			
10.7.2	Installation variants (A and B) for recirculation appliances	140			
10.7.3	Preparing kitchen units for installation variant A (floor unit with continuous back panel).....	141			
10.7.4	Installation dimensions	141			
10.7.5	Preparing kitchen units for installation variant B (floor unit with false floor under the cooktop).....	142			
10.7.6	Installation dimensions	143			
10.7.7	Preparing the cooktop.....	143			

1 General information

These instructions contain important information to protect you from injury and prevent damage to the appliance.

Please read these instructions carefully before installing or using the appliance for the first time.

Other documents apply alongside these instructions. Please by all means adhere to all documents that form part of the scope of delivery.

Assembly, installation and commissioning must always occur in line with national laws, regulations and standards. The work must be performed by qualified specialists who are familiar with and comply with the supplementary regulations of the local utility companies.

All safety and warning information as well as the handling instructions in the accompanying documents must be observed.

1.1 Liability

BORA Holding GmbH, BORA Vertriebs GmbH & Co KG, BORA APAC Pty Ltd and BORA Lüftungstechnik GmbH – hereinafter referred to as BORA – does not assume any liability for damage arising from disregard for or non-adherence to the documents included in the scope of delivery!

Furthermore, BORA shall not be held liable for damage caused by improper installation or failure to observe the safety and warning instructions!

1.2 Validity of the operating and installation instructions

These instructions apply to several appliance versions. It is therefore possible that some of the features described do not apply to your appliance. The details of the figures contained herein may differ from some appliance versions and are to be understood as schematic diagrams.

1.3 Product conformity

Directives

The appliances meet the following EU/EC directives:
2014/30/EU EMC Directive
2014/35/EU Low Voltage Directive
2009/125/EC Ecodesign Directive
2011/65/EU RoHS Directive

1.4 Presentation of information

We use standard formatting, numbering, symbols, safety instructions, terms and abbreviations so that you can work quickly and safely when using this manual.

The term “appliance” is used to refer to cooktops, cooktop extractors or cooktops with integrated cooktop extractor.

Instructions are indicated with an arrow.

▶ Always follow all instructions in the prescribed order.

Enumerations are indicated with a bullet point at the start of the line:

- Enumeration 1
- Enumeration 2

i Information notes point to special features that must be taken into account.

Safety and warning instructions

The safety and warning instructions in this manual are emphasised with symbols and signal words.

Safety and warning instructions are structured as follows:

WARNING SYMBOL AND SIGNAL WORD!



Type and source of danger

Results of non-compliance

► Measures to minimise risk

Please note:

- warning symbols draw attention to a high risk of injury.
- The signal word indicates the severity of that risk.

Warning symbol	Signal word	Risk
	Danger	Indicates an immediate, hazardous situation which causes death or serious injury if not respected.
	Warning	Indicates a potentially hazardous situation which can cause death or serious injury if not respected.
	Caution	Indicates a potentially hazardous situation which can cause minor injury or damage to property if not respected.

Tab. 1.1 Meaning of the warning symbols and signal words

Figures

All measurements are provided in millimetres.

2 Safety

The appliance complies with the stipulated safety requirements. The user is responsible for the safe use of the appliance, cleaning and maintenance. Improper use can lead to personal injury and damage to property.

2.1 Intended use

The appliance is solely intended for preparing food in private households.

This appliance is not intended for:

- outdoor use
- heating rooms
- cooling, ventilating or dehumidifying rooms
- use in mobile installation sites such as motor vehicles, ships or aeroplanes
- use with an external timer or a separate remote control system
- use at altitudes of over 2000 m (metres above sea level)
- use when not fully installed

Any other use or any use that goes beyond that which is described here is classed as unintended.

i BORA does not assume any liability for damages caused by incorrect installation, improper use or incorrect operation.

All misuse is prohibited!

2.2 People with limited abilities

Children

The appliance can be used by children aged 8 and over if they are supervised or have been instructed how to use the appliance safely and understand the resultant risks.

Children must not play with the appliance.

- ▶ Use the child lock in order to prevent children from switching on the appliances or changing the settings when they are unattended.
- ▶ Supervise children in the vicinity of the appliance.
- ▶ Do not store any items that could be of interest to children in storage spaces above or behind the appliance . Otherwise, they will be tempted to climb onto the appliance .

i Any work involving cleaning and maintenance must not be carried out by children unless they are supervised at all times while doing so.

People with reduced physical, sensory or mental capacities

The appliance can be used by people with reduced physical, sensory or mental capacities or a lack of experience and/or knowledge if they are supervised or have been instructed how to use the appliance safely and understand the resultant risks. Operation can be restricted using the child lock.

⚠ DANGER!

Risk of burns from hot cookware and food

Handles projecting over the edge of the worktop are asking to be grabbed.

- ▶ Keep children away from hot cooking zones or ensure they are supervised at all times.
- ▶ Do not turn pot and pan handles so they stick out beyond the work surface.
- ▶ Make sure that hot pots and pans cannot be pulled down.
- ▶ If necessary, use suitable stove guards or covers.
- ▶ Only use stove guards and covers that are approved by the appliance manufacturer; otherwise, there is a risk of accidents.
- ▶ To choose a suitable stove guard, contact your specialist retailer or the BORA Service Team.

2.3 General safety instructions

⚠ DANGER!

Packaging components are a choking hazard

Packaging components (e.g. film, polystyrene) can be life-threatening for children.

- ▶ Store all packaging components out of reach of children.
- ▶ Dispose of the packaging properly and immediately.

⚠ DANGER!

Risk of electric shock or injury from damaged surfaces

The underlying electronics can be exposed or damaged due to fissures, fractures or cracks in appliance surfaces (e.g. damaged glass), particularly in the vicinity of the operating unit. This can cause an electrical shock. Furthermore, a damaged surface can cause injuries.

- ▶ Do not touch the damaged surface.
- ▶ If there are any cracks, fissures or fractures, switch the appliance off immediately.
- ▶ Securely disconnect the appliance from the mains using the LS switch, fuses, automatic circuit breakers or contactor.
- ▶ Contact BORA Service.

⚠ WARNING!**Risk of injury or damage due to incorrect components or unauthorised modifications**

Incorrect components can lead to personal injury or damage to the appliance. Modifications, additions or alterations to the appliance can lead to safety risks.

- ▶ Only use original components.
- ▶ Do not make any modifications, additions or alterations to the appliance.

⚠ WARNING!**Risk of injury due to mechanical damage on the appliance**

Mechanical damage (e.g. cracks, deformation, separation of adhesive seals, etc.) to the appliance, as well as to cables and accessories can cause injuries.

- ▶ Do not operate the appliance.
- ▶ Do not try to repair or replace damaged components yourself.
- ▶ Contact BORA Service.

CAUTION!**Appliance components can cause injury if dropped**

Appliance components (e.g. pan supports, operating controls, covers, grease filters, etc.).

- ▶ Place any appliance components that have been removed in a safe place near the appliances.
- ▶ Ensure that no components removed from the appliances can fall on the floor.

CAUTION!**Risk of injury from heavy lifting**

If not handled correctly, carrying and installing appliances can cause injury to the limbs or torso.

- ▶ If necessary, carry and install the appliance with another person.
- ▶ Use appropriate aids to prevent damage or injury.

CAUTION!**Damage from improper use**

The appliance surfaces must not be used as work or storage surfaces. This can damage the appliances (particularly in the case of hard and sharp objects).

- ▶ Never use the appliances as work or storage surfaces.
- ▶ Keep hard or sharp objects away from the appliance surfaces.

Faults and errors

- ▶ In the case of faults and errors in the “Troubleshooting” chapter.
- ▶ In the event of any faults or errors that are not mentioned, switch the appliance off and contact BORA Service.

Pets

- ▶ Keep pets away from the appliance.

2.4 Safety information for installation

- i** The appliance must only be installed and assembled by trained specialists who are familiar with and comply with the standard national regulations and supplementary regulations of the local utility companies.
- i** During installation maintain the minimum clearance stated in the “Installation” (“Safety clearances”) chapter.
- i** Work on electrical components must only be conducted by trained electrical personnel.
- i** The appliance may only be installed with the power disconnected.

The electrical safety of the appliance is only guaranteed if it is connected to a protective conductor system that has been installed in line with regulations. Ensure that this basic safety precaution is met.

The appliance must be suitable for the regional voltage and frequency.

- ▶ Check the information on the identification plate and in the event of deviations, do not connect the appliance.
- ▶ Do not connect the appliance to the mains until the duct system has been installed or the recirculation filter has been fitted.
- ▶ Only use the connection cables supplied. Where necessary these are included in the scope of delivery.
- ▶ Do not use the appliance until installation is complete. This is the only way to ensure safe operation.
- ▶ Conduct all work extremely attentively and conscientiously and in accordance with these instructions.
- ▶ Before handing the appliance or system over to the end user, ensure that it has been correctly installed.

⚠ DANGER!**Risk of electric shock from damaged appliance**

A damaged appliance can cause an electric shock.

- ▶ Check the appliance for visible damage prior to installation.
- ▶ Do not install or connect any damaged appliances.
- ▶ Do not operate any damaged appliances.

2.4.1 Safety instructions – cooktop extractor installation

⚠ DANGER!**Risk of electric shock from incorrect stripping of cables**

Incorrect stripping of the connection cable to external switching devices results in a risk of electric shock.

- ▶ Ensure that the stated stripping lengths are adhered to.

⚠ WARNING!**Risk of injury due to moving fan wheel**

There is a risk of injury while the fan is turning.

- ▶ Only install the appliance with the power disconnected.
- ▶ Connect both sides of the fan to the duct system before commissioning.

Special safety instructions for the planning of extractor systems

⚠ DANGER!**Risk of smoke inhalation**

When the cooktop extractor is used in exhaust air mode, it draws in air from the room it is installed in and from neighbouring rooms. Without sufficient air, there will be a drop in air pressure. When used at the same time as a fireplace that is dependent on the air in the room, noxious gases can be sucked into the living areas from the chimney or outlet shaft.

- ▶ Make sure that there is always a sufficient air supply.
- ▶ Only use reliable, tried-and-tested switching devices, (e.g. window contact switch, low pressure warning device) and have them approved by a qualified expert (certified chimney sweep).

Ducting connected to wall sleeves

In the case of straight ducting and a distance < 900 mm between the fan and wall sleeve, a safety guard must be provided for (available as an accessory).

2.4.2 Safety information for cooktop installation

⚡ DANGER!

Risk of electric shock from incorrect mains connection

Connecting the appliance to the mains incorrectly poses a risk of electric shock.

- ▶ Make sure that the appliance has a fixed connection to the mains voltage.
- ▶ Make sure that the appliance is connected to a properly installed protective conductor system.
- ▶ Make sure that technical equipment is provided to enable all of the appliance's poles to be disconnected from the mains with a contact opening width of at least 3 mm (LS switch, fuses, automatic circuit breakers, contactor).

⚡ DANGER!

Risk of electric shock from damaged power supply cable

If the power supply cable is damaged (e.g. during installation or by coming into contact with hot cooking surfaces), this can cause an (lethal) electric shock.

- ▶ Make sure that the connection cable does not become trapped or damaged.
- ▶ Make sure that the power supply cable does not come into contact with hot cooking surfaces.

2.5 Safety instructions – operation

- ▶ Do not use the appliance until installation is complete. This is the only way to ensure safe operation.
- ▶ Make sure that the base of the cookware as well as the appliance surfaces are clean and dry.
- ▶ Always lift (do not drag) cookware to prevent scratching and abrasion on the appliance surface.
- ▶ Do not use the appliance as a storage surface.
- ▶ Switch off the appliance after use.

⚡ WARNING!

Risk of burning from hot appliances

Certain appliances and their exposed parts become hot during use. They should be left to cool down completely after switching off. Touching hot surfaces can cause serious burns.

- ▶ Do not touch hot appliances.
- ▶ Pay attention to the residual heat indicator.

⚠ WARNING!**Risk of burns due to power cut**

During or after a power cut a cooktop that was previously in operation may still be hot.

- ▶ Do not touch the appliance while it is still hot.
- ▶ Keep children away from the hot appliance.

⚠ DANGER!**Risk of fire from overheated oil or fat**

Oil or fat can quickly heat up and ignite.

- ▶ Never leave the appliance unattended when cooking with oil or fat.
- ▶ Never extinguish oil or fat fires with water.
- ▶ Switch off the appliance.
- ▶ Extinguish the fire using a pan lid or a fire blanket, for example.

⚠ WARNING!**Risk of burning and fire from hot objects**

The appliance and its exposed parts are hot during operation and the cooling phase. Objects in contact with hot appliance components heat up very quickly and can cause severe burns (this particularly applies to metal objects such as knives, forks, spoons, lids or appliance components) or catch fire.

- ▶ Do not place any items on the appliance.
- ▶ Please use suitable tools (pot holders, oven gloves).

CAUTION!**Damage caused by hot cookware**

Hot cookware can damage certain components in the appliance.

- ▶ Do not put hot cookware down in the area of the operating panel.
- ▶ Keep hot cookware away from the air inlet nozzle.

2.5.1 Safety instructions – cooktop extractor operation

⚠ WARNING!**Fire risk from flambéing**

While the cooktop extractor is working, it sucks up grease from cooking. Flambéing food can cause the grease to catch fire.

- ▶ Clean the cooktop extractor regularly.
- ▶ Never work with a naked flame while the cooktop extractor is running.

CAUTION!**Damage caused by objects or paper suctioned in**

Small and light items, such as cleaning cloths made from material or paper, can be suctioned into the cooktop extractor. This can damage the fan or impair the exhaust performance.

- ▶ Do not store any items or paper on the cooktop extractor.
- ▶ Only operate the integrated cooktop extractor with the grease filter fitted.

CAUTION!**Damage caused by grease and dirt deposits**

Grease and dirt deposits can prevent the cooktop extractor from functioning properly.

- ▶ Never use the cooktop extractor without a correctly fitted stainless steel grease filter.

Special safety instructions for using the exhaust air mode**⚠ DANGER!****Risk of smoke inhalation**

When the cooktop extractor is used in exhaust air mode, it draws in air from the room it is installed in and from neighbouring rooms. Without sufficient air, there will be a drop in air pressure. When used at the same time as a fireplace that is dependent on the air in the room, noxious gases can be sucked into the living areas from the chimney or outlet shaft.

- ▶ Make sure that there is a sufficient air supply at all times.
- ▶ Only use reliable, tried-and-tested switching devices, (e.g. window contact switch, low pressure warning device) and have them approved by a qualified expert (certified chimney sweep).

Special safety instructions for using the recirculation mode

When cooking, additional moisture is released into the ambient air. In recirculation mode, only a slight amount of moisture is removed from the cooking vapour.

- ▶ When using recirculation mode, ensure a sufficient supply of fresh air, e.g. by opening a window.
- ▶ Ensure a normal and comfortable room climate (humidity of 45–60%), e.g. by opening natural ventilation openings or using domestic ventilation systems.
- ▶ After every use in recirculation mode, switch the cooktop extractor to a low power level for about 20 minutes or activate the automatic after-run function.

2.5.2 Safety instructions – cooktop operation

- ▶ Do not simply rely on the pan size recognition function on induction cooktops; always switch the appliance off after use.

⚠ DANGER!

Danger of fire caused by leaving the cooktop unattended

Oil or fat can quickly heat up and ignite.

- ▶ Never leave oil or fat to heat up unattended.
- ▶ Never extinguish oil and fat fires with water.
- ▶ Switch off the cooktop.
- ▶ Extinguish the fire using a pan lid or a fire blanket, for example.

⚠ DANGER!

Risk of explosion caused by flammable liquids

Flammable liquids in the vicinity of a cooktop can explode and cause serious injury.

- ▶ Do not spray aerosols near the appliance when it is in use.
- ▶ Do not place any flammable liquids in the vicinity of a cooktop.

⚠ WARNING!

Risk of burns from hot liquids boiling over

Unattended pans can boil over allowing hot liquids to escape.

- ▶ Keep an eye on pans when cooking.
- ▶ Avoid over-cooking.

⚠ WARNING!

Risk of burns from hot steam

Liquid between the cooking zone and the pan base can evaporate and cause burns.

- ▶ Make sure that the cooking zone and the pan base are always dry.

CAUTION!

Damage caused by sugary and salty foods

Sugary and salty foods and juices can damage the hot cooking zone.

- ▶ Make sure sugary and salty foods or juices do not get onto the cooking zone while it is hot.
- ▶ Remove sugary and salty foods and juices from the hot cooking zone immediately.

Special safety instructions for the operation of induction cooktops

Effect on pacemakers, hearing aids and metal implants:

Induction cooktops generate a high-frequency electromagnetic field in the area of the cooking zones. The cooking zones may affect pacemakers, hearing aids or metal implants negatively or disturb their function when in close proximity. A reduced function of the pacemaker is unlikely.

- ▶ If in doubt, contact the manufacturer of your medical device or your doctor.

2.6 Safety instructions – cleaning and maintenance

The appliance must be cleaned at regular intervals. Dirt can lead to damage, restriction of functions, or bothersome odours. In the worst case scenario, this can become a hazard.

- ▶ Please follow all instructions in the “Cleaning and Maintenance” chapter.
- ▶ Remove dirt immediately.
- ▶ When cleaning, only use non-abrasive detergents to prevent scratching and abrasion on the surface.
- ▶ When cleaning, ensure that no water penetrates the appliance. Use only a slightly damp cloth. Never spray the appliance with water. Water penetration can cause damage!
- ▶ Do not use a steam cleaner for cleaning. Steam can cause a short circuit on live parts and thus lead to property damage.

Special safety instructions for cooktop extractor cleaning and maintenance

- ▶ Keep the ventilation openings in the unit below open and clean.

⚠ WARNING!

Fire risk from fat deposits

The risk of fire can be increased by failure to clean the grease filter properly and on a regular basis, or if the filter change is overdue.

- ▶ Clean and replace the filter at regular intervals.

⚠ WARNING!

Risk of injury when opening the bottom housing cover

There is a risk of injury while the fan is turning.

- ▶ Switch off the appliance and disconnect it from the mains before removing covers in the vicinity of the fan.

Special safety instructions for cooktop cleaning and maintenance

- ▶ Whenever possible, clean the cooktops after every use.
- ▶ Only clean the cooktops when they have cooled down.

2.7 Safety instructions – repairs, servicing and spare parts

- i** The appliance must only be repaired and serviced by trained specialists who are familiar with and comply with the standard national regulations and supplementary regulations of the local utility companies.
- i** Work on electrical components must only be conducted by trained electrical personnel.
- ▶ Before any repair work, safely disconnect the appliance from the mains supply.

⚠ WARNING!

Risk of injury or damage from improper repairs

Incorrect components can lead to personal injury or damage to the appliance. Modifications, additions or alterations to the appliance can lead to safety risks.

- ▶ Only use original spare parts for repairs.
 - ▶ Do not make any modifications, additions or alterations to the appliance.
- i** A damaged power supply cable must be replaced by a suitable power supply cable. This may only be done by an authorised member of the Customer Care team.

2.8 Safety instructions – disassembly and disposal

- i** The appliance must only be disassembled by trained specialists who are familiar with and comply with the standard national regulations and supplementary regulations of the local utility companies.
- i** Work on electrical components must only be conducted by trained electrical personnel.
- ▶ Before disassembly, safely disconnect the appliance from the mains supply.

⚡ DANGER!**Risk of electric shock from incorrect disconnection**

Incorrectly disconnecting the appliance from the mains results in a risk of electric shock.

- ▶ Securely disconnect the appliance from the mains using LS switches, fuses, automatic circuit breakers or contactors.
- ▶ Use an authorised measuring device to ensure that there is no power to the appliance.
- ▶ Do not touch exposed contacts on the electronic unit as they can contain residual charge.

3 Technical data

3.1 X Pure (PUXA, PUXU)

Parameter	Value
Multiphase supply voltage	380 - 415 V 2N / 3N
Single-phase supply voltage	220 - 240 V
Frequency	50 Hz - 60 Hz
Maximum power consumption	7600 W (4400 W / 3600 W)
Fuse protection/	3 x 16 A
Three-phase power supply	
Fuse protection/	2 x 16 A
Two-phase power supply	
Fuse protection/	1 x 32 A
Single-phase power supply	(1 x 20 A / 1 x 16 A)
Dimensions (width x depth x height)	830 x 515 x 199 mm
Weight	23 kg (PUXA)
(incl. accessories/packaging)	24,5 kg (PUXU)
Cooktop	
Surface material	glass ceramic
Cooktop power levels	1 - 9, P
Size of front cooking zone	230 x 230 mm
Front cooking zone power setting output	2100 W 3000 W
Size of rear cooking zone	230 x 230 mm
Rear cooking zone power setting output	2100 W 3000 W
Cooktop energy consumption (pan size)	
Front left cooking zone 1 (150 mm)	179,4 Wh/kg
Rear left cooking zone 2 (180 mm)	176,2 Wh/kg
Cooking zone 1 and 2 bridget (240 mm)	191,5 Wh/kg
Front right cooking zone 3 (150 mm)	174,7 Wh/kg
Rear right cooking zone 4 (180 mm)	177,5 Wh/kg
Cooking zones 3 and 4 bridget (240 mm)	197,1 Wh/kg
Total (average)	182,7 Wh/kg
Exhaust air system (PUXA)	
Cooktop extractor power levels	1 - 9, P
Exhaust air connection	BORA Ecotube
Recirculation system (PUXU)	
Cooktop extractor power levels	1 - 9, P
Size of exhaust opening (W x H)	445 x 137 mm
Maximum activated charcoal filter service life	150 h (1 year)

Tab. 3.1 Technical data X Pure (PUXA, PUXU)

Device dimensions PUXA

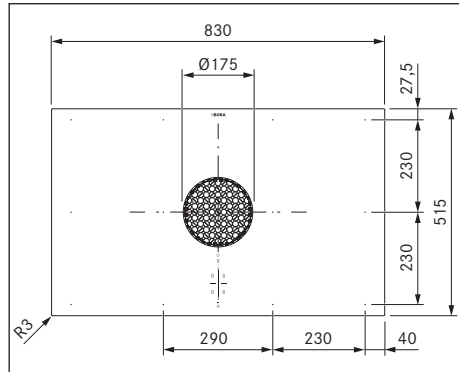

Fig. 3.1 PUXA device dimensions top view

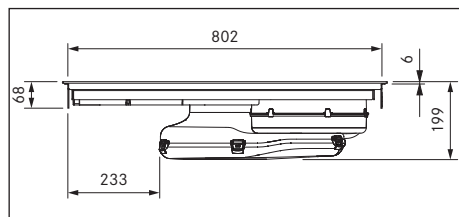

Fig. 3.2 PUXA device dimensions front view

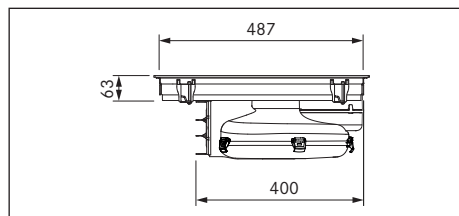

Fig. 3.3 PUXA device dimensions side view

Device dimensions PUXU

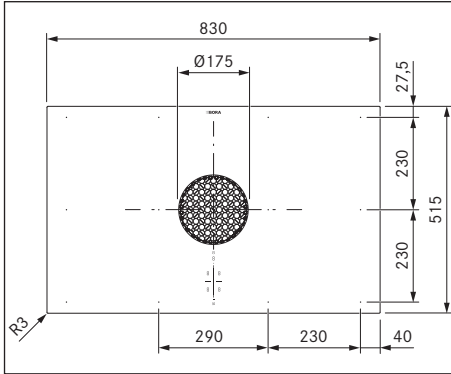

Fig. 3.4 PUXU device dimensions top view

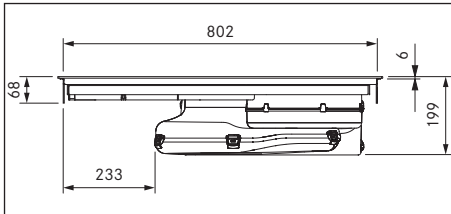

Fig. 3.5 PUXU device dimensions front view

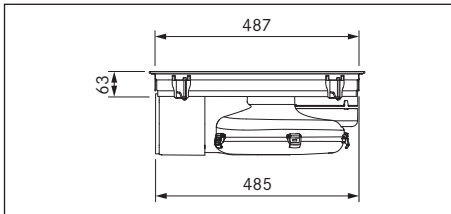

Fig. 3.6 PUXU device dimensions side view

3.2 Pure (PURA, PURU)

Parameter	Value
Multiphase supply voltage	380 - 415 V 2N / 3N
Single-phase supply voltage	220 - 240 V
Frequency	50 Hz - 60 Hz
Maximum power consumption	7600 W (4400 W / 3600 W)
Fuse protection/ Three-phase power supply	3 x 16 A
Fuse protection/ Two-phase power supply	2 x 16 A
Fuse protection/ Single-phase power supply	1 x 32 A (1 x 20 A / 1 x 16 A)
Dimensions (width x depth x height)	760 x 515 x 199 mm
Weight	22,5 kg (PURA)
(incl. accessories/packageing)	24,4 kg (PURU)
Cooktop	
Surface material	glass ceramic
Cooktop power levels	1 - 9, P
Size of front cooking zone	Ø 210 mm
Front cooking zone power setting output	2300 W 3000 W
Size of rear cooking zone	Ø 175 mm
Rear cooking zone power setting output	1400 W 2100 W
Cooktop energy consumption (pan size)	
Front left cooking zone 1 (210 mm)	186,3 Wh/kg
Rear left cooking zone 2 (180 mm)	177,2 Wh/kg
Front right cooking zone 3 (210 mm)	191,5 Wh/kg
Rear right cooking zone 4 (150 mm)	177,2 Wh/kg
Total (average)	183,1 Wh/kg
Exhaust air system (PURA)	
Cooktop extractor power levels	1 - 9, P
Exhaust air connection	BORA Ecotube
Recirculation system (PURU)	
Cooktop extractor power levels	1 - 9, P
Size of exhaust opening (W x H)	445 x 137 mm
Maximum activated charcoal filter service life	150 h (1 year)

Tab. 3.2 Technical data Pure (PURA, PURU)

Device dimensions PURA

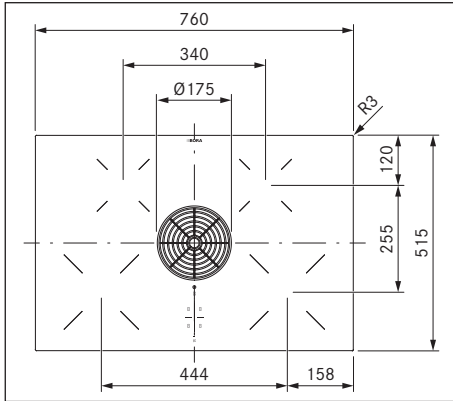

Fig. 3.7 PURA device dimensions top view

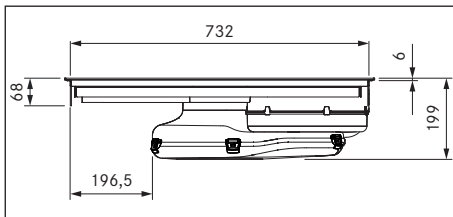

Fig. 3.8 PURA device dimensions front view

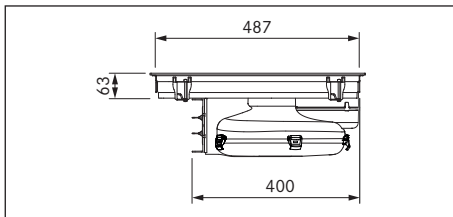

Fig. 3.9 PURA device dimensions side view

Device dimensions PURU

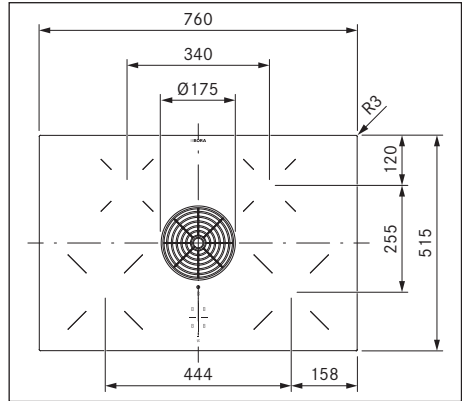

Fig. 3.10 PURU device dimensions top view

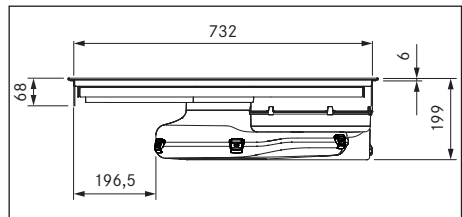

Fig. 3.11 PURU device dimensions front view

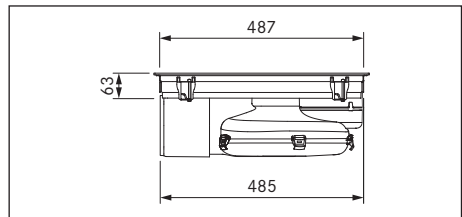

Fig. 3.12 PURU device dimensions side view

4 Energy labelling

Product information according to delegated regulation (EU) no. 65/2014 and regulation (EU) no. 66/2014.

Manufacturer	BORA		BORA	
	PUXA		PURA	
Model identification	Symbol	Value	Value	Unit
Energy consumption				
Annual energy consumption	AEC _{hood}	35,6	33,7	kWh/a
Energy efficiency class	-	A+	A+	-
Energy efficiency index	EEI _{hood}	43,3	42,8	-
Flow volume				
Fluid dynamic efficiency	FDE _{hood}	32,9	32,6	-
Fluid dynamic efficiency class	-	A	A	-
Minimum air flow in normal use	-	187,3	179,1	m ³ /h
Maximum air flow in normal use	-	563,3	548,3	m ³ /h
Maximum air flow on intensive or boost setting (power setting)	Q _{max}	626,1	622	m ³ /h
Measured air flow rate at best efficiency point	Q _{BEP}	313,4	304,3	m ³ /h
Measured air pressure at best efficiency point	P _{BEP}	460,7	446	Pa
Measured electric power input at best efficiency point	W _{BEP}	122,0	115,5	W
Time increase factor	f	0,8	0,8	-
Lighting				
Lighting efficiency	LE _{hood}	*	*	lx/W
Lighting efficiency class	-	*	*	-
Nominal power of the lighting system	W _L	*	*	W
Average illumination of the lighting system on the cooking surface	E _{middle}	*	*	lx
Grease filtering				
Grease filtering efficiency	GFE _{hood}	96,4	97,8	%
Grease filtering efficiency class	-	A	A	-
Noise				
Airborne acoustical A-weighted sound power emissions at minimum speed available in normal use	-	41,2	40,1	dB(A) re_1pW
Airborne acoustical A-weighted sound power emissions at maximum speed available in normal use	-	66,4	65,8	dB(A) re_1pW
Airborne acoustical A-weighted sound power emissions on intensive or boost setting (power setting)	-	68,6	67,7	dB(A) re_1pW
Sound pressure level at minimum speed available in normal use**	-	28,6	27,5	LpA in dB re 20 µPa
Sound pressure level at maximum speed available in normal use**	-	53,8	53,2	LpA in dB re 20 µPa
Sound pressure level on intensive or boost setting (power setting)**	-	56,0	55,1	LpA in dB re 20 µPa
Power consumption				
Power consumption in off mode	P _o	0,18	0,12	W
Power consumption in standby mode	P _s	*	*	W

Tab. 4.1 Energy labelling

* Not applicable to this product.

** Voluntary information

The sound pressure level has been determined from a distance of 1 m (distance-dependent level recording) on the basis of the sound power level established in EN 60704-2-13.

5 Appliance description

Observe all safety and warning information during operation (see "2 Safety").

5.1 Model description

Model	Long description
PUXA	X Pure surface induction cooktop with integrated cooktop extractor – exhaust air
PUXU	X Pure surface induction cooktop with integrated cooktop extractor – recirculation
PURA	Pure induction cooktop with integrated cooktop extractor – exhaust air
PURU	Pure induction cooktop with integrated cooktop extractor – recirculation

Tab. 5.1 Model description

5.2 System description

5.2.1 Structure

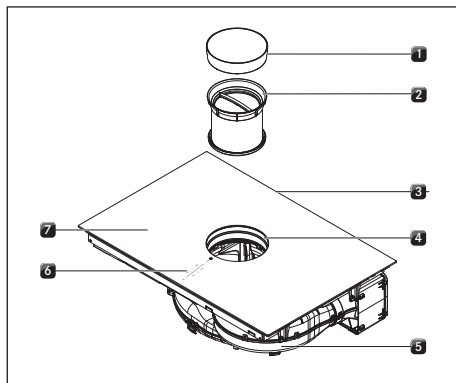

Fig. 5.1 Cooktop

- [1] Air inlet nozzle
- [2] Stainless steel grease filter
- [3] Cooktop
- [4] Inlet opening
- [5] Fan
- [6] Operating panel
- [7] Cooking zone (x 4)

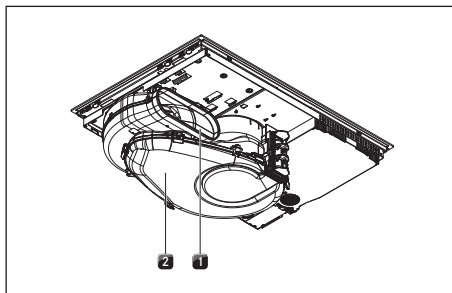

Fig. 5.2 Rear view of PUXA, PURA

- [1] Exhaust opening
- [2] Air guiding housing with housing base

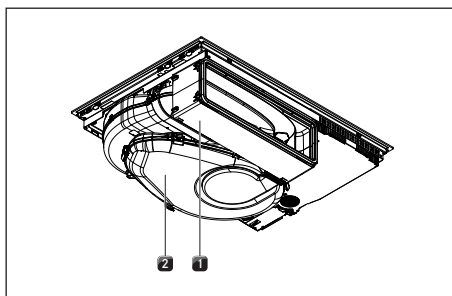

Fig. 5.3 Rear view of PUXU, PURU

- [1] Air cleaning box with telescopic pull-out
- [2] Air guiding housing with housing base

5.2.2 Operating panel

The cooktop extractor and cooktops are operated via a central operating panel. The operating panel is fitted with electronic sensor buttons and display panels. The sensor buttons respond to finger contact (touch zones).

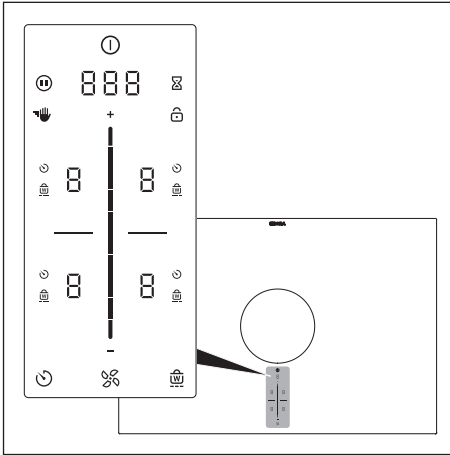

Fig. 5.4 Central touch/slider operating panel

Touch zones/buttons

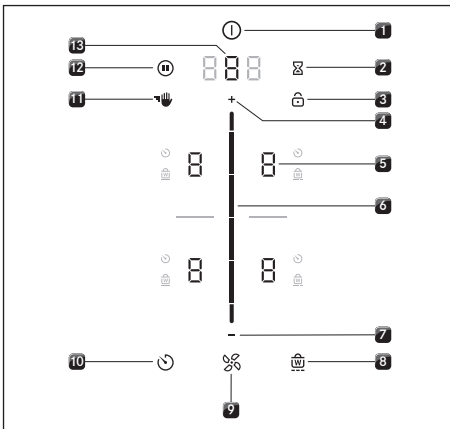

Fig. 5.5 Touch zones/buttons

- [1] Switching on/off
- [2] Short-time timer (egg timer)
- [3] Control lock
- [4] Power level setting zone plus
- [5] Cooking zone selection (x 4)
- [6] Touch slider (power level setting zone)
- [7] Power level setting zone minus
- [8] Heat retention function
- [9] Fan functions
- [10] Cooking zone timer
- [11] Cleaning lock

- [12] Pause function
- [13] Select fan/Call up menu

Indicator zones

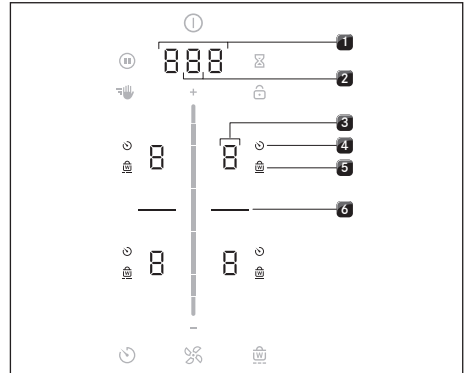













Fig. 5.6 Indicator zones



















- [1] Multi-function display
- [2] Fan display
- [3] Cooking zone indicator (x 4)
- [4] Cooking zone timer indicator (x 4)
- [5] Warming indicator (x 4)
- [6] Dividing line

5.2.3 Symbols

Symbols	Description	Function/meaning
	Power button	Switching on/off
	Pause button	Activating/deactivating the pause function
	Cleaning button	Activating/deactivating the cleaning lock
	Egg timer button	Setting the short-time timer (egg timer)
	Lock button	Control lock
	Slider	Setting values
	Plus button	Increasing values
	Minus button	Decreasing values
	Fan button	Activating/deactivating the automatic extractor function, cancelling the after-run function
	Timer button	Setting the cooking zone timer
	Warming button	Activating/deactivating the heat retention function



Tab. 5.2 Meaning of the symbols displayed (icons)

5.2.4 7-segment display

Multi-function display	Meaning
Fan display	
	Power levels
	Power setting
	Inactive
	Automatic extractor function
	Automatic after-run
	Filter service
Multi-function display	
	Time indication
e.g. 	Error code
Cooking zone indicator	Meaning
Cooking zone indicator	
	Power level
	Power setting
	Heat retention level (Pure)
	Heat retention level 1 (X Pure)
	Heat retention level 2 (X Pure)
	Heat retention level 3 (X Pure)
	Pan size recognition
	Inactive
	Residual heat indicator (cooking zone is switched off but still hot)
	Error

Tab. 5.3 Meaning of the 7-segment displays



5.2.5 Lighting

-  The operating panel has 2 different levels of lighting (100% and 50%).
-  On principle the system adapts the lighting to the current operating scenario. Relevant display elements are more brightly lit and irrelevant ones are dimmed. Unavailable functions are faded out.

Lighting	Use
100%	Function is active and selected
50%	Function is inactive but can be selected
0% (no indicator)	Function is unavailable

Tab. 5.4 Lighting

5.2.6 Sounds

-  The volume of the acoustic signals can be set in the menu (0% to 100%).
-  The acoustic signal for the power button cannot be set to 0.
-  Safety-relevant acoustic signals are always emitted with the volume at 100%.

The system basically differentiates between two different types of acoustic signals:

Acoustic signal	Purpose
Short individual beep (0.1 s)	Confirmation of a selection
Sequence of beeps	Interaction required

Tab. 5.5 Sounds

5.3 How the cooktop extractor works

Depending on the model you purchased, the cooktop extractor can be operated as an exhaust air or a recirculating air version.



Exhaust air mode

The air suctioned away is purified by the grease filter and expelled into the open air via a duct system.

The exhaust air must not be expelled into:

- a smoke or exhaust gas flue that is in operation
- a shaft used for the aeration of rooms where fireplaces are installed.

If the exhaust air is to be directed into a smoke or exhaust gas flue that is not in use, the installation must be checked and approved by the responsible heating engineer.



Recirculation mode

The air suctioned away is purified by the grease filter and an activated charcoal filter and fed back into the room in which the appliance is installed.

To prevent odours in recirculation mode, an odour filter must be used.

For health and hygiene reasons, the activated charcoal filter must be replaced at the

recommended intervals (see “8 Cleaning and maintenance”).

-  In recirculation mode, ensure sufficient ventilation and aeration to expel humidity.

5.4 How the induction cooktop works

An induction coil is located underneath an induction cooking zone. If the cooking zone is switched on, this coil creates a magnetic field that acts directly on the base of the pot thus heating it up. The cooking zone is only indirectly heated up by the heat emitted by the pot. Cooking zones with induction only work if the cookware has a magnetisable base. Induction automatically takes into account the size of the cookware used which means that only the area in the cooking zone covered by the base of the pot is heated up.

5.4.1 Suitable cookware

-  The heating and heat-through times for the cookware base, as well as the cooking results, are significantly influenced by the structure and material of the cookware.



Cookware with this symbol is suitable for induction cooktops. The cookware used for the induction cooktop must be made of metal, feature magnetic properties and possess an ample base.

Suitable cookware is made of:

- stainless steel with a magnetisable base
- enamelled steel
- cast iron
- ▶ Perform a magnet test, if necessary. If a magnet sticks to the base of the utensils, they are normally induction compatible.
- ▶ Pay attention to the cookware base. The bottom of the cookware should not show any sign of curvature. Due to incorrect hob temperature monitoring, this curvature may cause the cookware to overheat. To avoid scratching the

cooktop, the base of the cookware must not have any sharp grooves or sharp edges.

- ▶ Place the cookware (without a mat or similar) directly onto the glass ceramic.
- ▶ Observe the minimum pot base diameter.

Appliance	Cooking zone	Minimum diameter of cookware base
PUXA	front	120 mm
	rear	120 mm
PUXU	front	120 mm
	rear	120 mm
PURA	front	120 mm
	rear	90 mm
PURU	front	120 mm
	rear	90 mm

Tab. 5.6 Minimum cookware diameter

5.4.2 Noises

The following noises may occur in the cookware when using induction cooking zones, depending on the material and the finish of the base:

- Humming may occur when using a high power level. This decreases or disappears when the power level is decreased.
- Crackling or whistling may occur due to the bases of cookware being made of different materials (e.g. sandwich base).
- Clicking sounds may occur during electronic switching procedures, especially at low power levels.
- Whirring may occur when the cooling fan is switched on. In order to increase the service life of the electronic system, the cooktop is equipped with a cooling fan. The cooling fan switches on automatically if the cooktop is used intensively. You will hear a whirring sound. The cooling fan may continue to run after the appliance has been switched off.

6 Functions and operation

- ▶ Observe all safety and warning information during operation (see “2 Safety”).

- i** Do not operate the integrated cooktop extractor with other cooktops.
- i** The cooktop should only be operated when the filter replacement cover, stainless steel grease filter and air inlet nozzle are installed (as well as the activated charcoal filter in the recirculation model).

6.1 General operating instructions

The cooktop extractor and cooktop are operated via a central operating panel. The operating panel is fitted with electronic sensor buttons and display panels. The sensor buttons respond to finger contact.

You operate the appliance by touching the corresponding sensor button with your finger (touch control).

6.2 Touch control

- i** The system recognises different touch commands. It differentiates between a brief touch (tap), a prolonged touch (long press) and vertical swiping movements with your finger (swipe).

Touch commands	Applicable to	Time (contact)
Tap	Buttons + slider	0.3 s
Long press	Buttons + slider	1–8 s
Swipe	Slider	0.1–8 s

Tab. 6.1 Touch control

6.3 Function overview

The X Pure and Pure cooktops come with different functions:

	X Pure		Pure	
	PUXA	PUXU	PURA	PURU
Short-time timer (egg timer)	✓	✓	✓	✓
Control lock	✓	✓	✓	✓
Cleaning lock	✓	✓	✓	✓
Cooktop extractor functions				
Automatic after-run	✓	✓	✓	✓
Fan power setting	✓	✓	✓	✓
Automatic extractor function	✓	✓	✓	✓
Filter service display		✓		✓
Cooktop functions				
Cooking zone power setting	✓	✓	✓	✓
Pan size recognition	✓	✓	✓	✓
Permanent pan size recognition	✓	✓	✓	✓
Automatic heat up function	✓	✓	✓	✓
Cooking zone timer	✓	✓	✓	✓
Pause function	✓	✓	✓	✓
Heat retention function			✓	✓
Variable heat retention function	✓	✓		
Bridging function	✓	✓		
Automatic bridging function	✓	✓		
Safety features				
Child lock	✓	✓	✓	✓
Residual heat indicator	✓	✓	✓	✓
Safety shut-down	✓	✓	✓	✓
Overheating protection	✓	✓	✓	✓

Tab. 6.2 Function overview

6.4 Operating the system

6.4.1 Switching the appliance on and off

Switching on

- ▶ Long press on the power button 
- The switch-on animation is displayed in the slider.
- If start-up is successful, the standard display will appear in the operating panel.

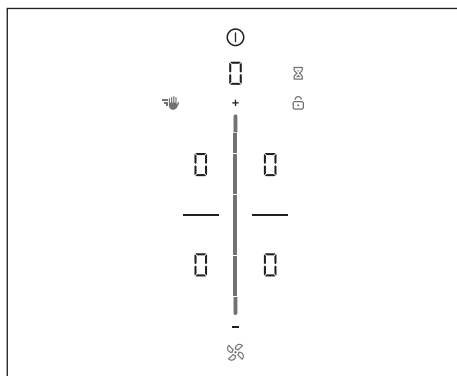



Fig. 6.1 Standard display after switching on

- i** If the child lock is active, the lock button will light up after system start-up . The standard display will only appear once it has been unlocked (see “6.7.1 Child lock”).



Switching off

- ▶ Long press on the power button 
- The switching-off animation is displayed.
- If the cooktop extractor has been on:
 - The fan symbol will light up and the automatic after-run function will start (the automatic after-run animation is displayed).
 - The display goes out when the after-run time has lapsed.
- If the cooktop has been on:
 - The residual heat indicator H is displayed for previously active and still hot cooking zones.
 - The display goes out when no more residual heat is present.

6.4.2 Short-time timer (egg timer)





The short-time timer emits both a visual and an acoustic signal after a time set by the user and provides the function of a conventional egg timer.

Activating the short-time timer

- ▶ Tap the egg timer button 
-  flashes in the multi-function display.
- The cooking zones in the display are dimmed.

Setting the time

- ▶ Select the desired power level:

Command	Increase time	Decrease time
Swipe	 upwards	 downwards
Tap	 (exact to the minute)	 (exact to the minute)

Tab. 6.3 Setting the time

- The egg timer button  starts to flash.

Starting the short-time timer

- ▶ Tap the flashing egg timer button 
- The set time starts to count down.
- The egg timer button and the remaining time are shown in the operating panel.

Time lapsed

- 10 seconds before the set time lapses, the system flashes the remaining time.
- In the last 5 seconds of the countdown an acoustic signal can be heard every second.
- The time indicator  changes to the fan power level.

Deactivating the short-time timer early

- ▶ Long press on the egg timer button 
- The short-time timer is stopped.
- The operating panel display changes to the standard display.

- i** If the appliance is switched off, the short-time timer will remain active.

6.4.3 Control lock

The control lock prevents the current settings from being changed accidentally or without permission.

- If the control lock is active, the symbol  lights up
- The functions are locked and the operating panel is dimmed (exception: power button).

Activating the control lock

- ▶ Long press on the lock button .
- The operating panel is dimmed.
- The lock button lights up.
- All functions are deactivated except for the power button and the lock button.

i If the system is switched off when the control lock is active, the control lock will no longer be active next time the system is switched on.

Deactivating the control lock

- ▶ Long press on the lock button .
- The standard display lights up and the operating panel is reactivated.
- The lock button is dimmed.

6.4.4 Cleaning lock

The cleaning lock prevents settings from being changed when wiping the operating panel during a cooking session. When activated, the operating panel is locked for 10 seconds. The remaining time is displayed. All appliance settings remain unchanged in the meantime. Once the time has lapsed you can use the functions again.

Activating the cleaning lock

- ▶ Tap the cleaning button .
- The cleaning button lights up.
- The operating panel is locked.
- The remaining seconds are shown in the multi-function display.

Deactivating the cleaning lock early

- ▶ Long press on the cleaning button .
- The cleaning button is dimmed.
- The operating panel is unlocked.

6.5 Operating the cooktop extractor



6.5.1 Switching the fan on and off

Switching the fan on

The fan is switched on by setting the fan power level.



- ▶ Set the fan power level.
- The fan symbol lights up.
- The set fan power level is shown in the multi-function display.

Switching the fan off

- ▶ Swipe downwards to power level 0 or
- ▶ tap  until power level 0 is reached or
- ▶ long press on the fan button  or
- ▶ long press on the fan power level in the multi-function display.
- The automatic after-run function is started.

6.5.2 Setting the fan power level



The fan power levels can be set in 3 different ways.

- ▶ By tapping a certain position on the slider  or
- ▶ by swiping until you reach the required power level or
- ▶ by tapping on  or .

6.5.3 Fan power setting

When the power setting is activated, maximum extractor power is available for a predefined time. This power setting makes it possible to suction away high levels of cooking vapours more quickly. After 5 minutes, the power setting is automatically switched to power level 9.

Activating the fan power setting

- ▶ Tap on  when power level 9 is active.
-  appears in the display.

Deactivating the fan power setting

The fan power setting is deactivated early if another power level is set.

6.5.4 Automatic extractor function

The extractor power level automatically adjusts itself depending on the current cooktop settings. No manual adjustment of the fan controls is necessary but it is possible. The extractor power is automatically adjusted to the highest power level used on all connected cooking zones. If the cooking zone power level is changed, the extractor power is automatically adjusted. The extractor power is adjusted after a 20 second delay.

Function	Power levels									
Cooking level	1	2	3	4	5	6	7	8	9	P
Extractor power	4	4	4	4	5	6	7	8	9	P

Tab. 6.4 Extraction performance and cooking level

Activating the automatic extractor function:

- ▶ tap the fan button .
- The fan symbol lights up.
- An animation appears on the slider.
- F is displayed.

Deactivating the automatic extractor function:

- ▶ swipe to a fan power level
- or
- ▶ tap the fan button .

6.5.5 Automatic after-run

The cooktop extractor continues to run at a lower level and switches off automatically after a defined time.

The duration of the after-run function can be set in the menu (10, 15 or 20 minutes). The default duration of the after-run function is 20 minutes.

- When the extractor is switched off, the automatic after-run function is activated.
- Once the automatic after-run period has lapsed, the cooktop extractor switches itself off.

Switching off the automatic after-run early

- ▶ tap the fan button .

- i** BORA expressly recommends use of the cooktop extractor after-run function.

6.5.6 Filter service display

The cooktop extractor filter service display is automatically activated when the end of the activated charcoal filter service life is reached (only in recirculation mode).



- F is displayed in the multi-function display.
- The filter service display is shown every time the cooktop extractor is switched on and remains active until the filter has been changed and the filter service display has been reset (see “7.3 Menu item 3: Showing the filter status and resetting filter service display”).
- The cooktop extractor can still be operated without limitations.

- i** The components of the grease filter require regular cleaning regardless of the filter service display (see “8 Cleaning and maintenance”).

6.6 Operating the cooktop

6.6.1 Pan size recognition

The cooking zone recognises the size of the cookware automatically and only targets the energy at that area. It also recognises cookware that is unsuitable or too small, or if there is no cookware present.

A cooking zone is not working if  /  are alternated in the display.

This happens if...

- ...it is switched on without cookware or with unsuitable cookware;
- ...the base diameter of the cookware is too small;
- ...the cookware is removed from a switched-on cooking zone.

If no pot is recognised 10 minutes after setting a power level, the cooking zone will switch off automatically.

6.6.2 Permanent pan size recognition





The appliance automatically recognises cookware and switches the corresponding cooking zone on. The cooking zone does not need to be switched on manually (see “7.7 Menu item 7: Permanent pan size recognition”).

6.6.3 Switching the cooking zone on/off

Switching on the cooking zone

- ▶ Tap on a cooking zone .
- The cooking zone controls are activated for 2 seconds and you can apply settings to the chosen cooking zone.
- The additional cooking zone functions appear.
- ▶ Repeat this process to operate further cooking zones if necessary.

Switching off the cooking zone

- ▶ Tap the required cooking zone.
- ▶ Swipe right down to the bottom until  appears in the cooking zone display
- or
- ▶ long press on the cooking zone
-  is displayed in the cooking zone display.
- After 2 seconds, the standard display appears.
- or
- ▶ tap  until  appears in the cooking zone display.



6.6.4 Setting cooking zone power levels

The high power output of induction cooktops results in the very quick heating up of cookware. In order to avoid burning food, slight adjustment is needed in comparison to conventional cooking systems when selecting the power level.



Activity	Power level
Melting butter and chocolate, breaking up gelatine	1
Keeping sauces and soups warm, soaking rice	1 - 3
Cooking potatoes, pasta, soups and ragouts, steaming fruit, vegetables and fish, defrosting food	2 - 6
Frying in coated pans, moderate frying (without overheating the fat) of pork cutlets or fish	6 - 7
Heating up fat, browning meat, cooking thickened sauces and soups, making omelettes	7 - 8
Bringing large amounts of liquid to the boil, searing steaks	9
Heating up water	P

Tab. 6.5 Recommendations for power levels

The specifications provided in the table are standard values. Depending on the cookware and filling quantity, it is recommended to either decrease or increase the power level.

-  The cooking zone power levels on the cooktops are shown in the corresponding cooking zone display as a 7-segment font (1 - 9).
-  Two seconds after the power level is changed, the operating panel display automatically returns to the standard display.

Adjusting the power level

- ▶ Tap the required cooking zone.
- The cooking zone power levels can be set in 3 different ways:
- ▶ by tapping a certain position on the slider
 - or
 - ▶ by swiping until you reach the required power level
 - or
 - ▶ by tapping on  or .

6.6.5 Cooking zone power setting

When the power setting is activated, maximum cooking zone power is available for a predefined time.

- The available power is targeted at the cooking zone, meaning that the max. power of the second cooking zone on that side is automatically reduced temporarily:
 - If the front cooking zone is operated using the power setting, a maximum power level of 7 can be selected in the rear cooking zone.
 - If the rear cooking zone is operated using the power setting, a maximum power level of 7 can be selected in the front cooking zone (max. power level 8 on Pure).
 - If the power level selected for the second cooking zone is too high, P will flash three times and the cooking zone will switch back to power level 9.

i Never heat up oil, fat and the like on the power setting. The bottom of the pan can overheat due to the high power output.

Activating the power setting for a cooking zone

- ▶ Tap on  when power level 9 is active.
- P appears in the cooking zone display.

Deactivating the power setting

- After 5 minutes, the cooking zone is automatically switched back to power level 9
- or
- the power setting is deactivated early if another power level is set.

6.6.6 Automatic heat up function

When the automatic heat up function is activated, the cooking zone works at full power for a certain time and is then automatically reset to the previously set level.

Power level (continuous cooking level)	Heating time in min:sec
1	00:40
2	1:00
3	2:00
4	3:00
5	4:20
6	7:00
7	2:00
8	3:00

Tab. 6.6 Heating time overview

Activating the automatic heat up function

- ▶ Tap the required cooking zone
- ▶ Setting the power level (= continuous cooking level)
- ▶ Long press on the slider  at a position lower than power level 9
- The automatic heat up function is activated.
- Whilst the automatic heat up function is active, the power level displayed will flash.
- When the heat up time has ended, the cooking zone will stay on the previously set continuous cooking level.

Deactivating the automatic heat up function early

The automatic heat up function is deactivated early if a lower power level is set.



- i** If the power level of a cooking zone is increased when the automatic heat up function is active, the automatic heat up function remains active. The time is restarted for the new continuous cooking level. If the cooking zone power level is decreased while the automatic heat up function is active, the automatic heat up function is deactivated.

6.6.7 Cooking zone timer

This automatic cut-off function automatically switches off the selected cooking zone once a preset time has lapsed. The cooking zone timer can also be used on several cooking zones at the same time (multi-timer).





- **i** To be able to activate the cooking zone timer function, a cooking zone power level must first be set.

Activating cooking zone timers

- ▶ Tap on a cooking zone
- The additional cooking zone functions are displayed.
- If the chosen cooking zone is not yet active (= power level ) a power level can now be set.
- ▶ Tap the timer button 
- The time  flashes in the multi-function display.

Setting the time



- ▶ Select the desired power level:

Command	Increase time	Decrease time
Swipe	 upwards	 downwards
Tap	 (exact to the minute)	 (exact to the minute)

Tab. 6.7 Setting the time

- The timer symbol  starts to flash.

Starting the cooking zone timer

- ▶ Tap the flashing timer button 
- The set time starts to count down.
- The timer symbol  is shown next to the cooking zone.
- The operating panel display changes to the standard display after 2 seconds.
- 10 seconds before the set time lapses, the system flashes the remaining time.
- In the last 5 seconds of the countdown an acoustic signal can be heard every second.

Showing the remaining time

The cooking zone timer is active and the time counts down:



- ▶ Tap the cooking zone
- The remaining time is shown in the multi-function display.

Changing the active cooking zone timer

- ▶ Tap a cooking zone with an active timer
- The remaining time is displayed.
- ▶ Tap the timer button 

- The timer is stopped.
- The remaining time flashes in the display.
- The system changes to input mode.
- ▶ Change the set time.
- ▶ Confirm the new set time and start the timer.



Multi-timer

- ▶ Tap on a different cooking zone
- The additional cooking zone functions are displayed.
- If the chosen cooking zone is not yet active (= power level ) a power level can now be set.
- ▶ Tap the timer button 
- The time  flashes in the multi-function display.
- Now the time can be set and the cooking zone timer started.

Switching the cooking zone timer off early

- ▶ Tap a cooking zone with an active timer
- The remaining time is displayed.
- ▶ Long press on the timer button 
- or
- ▶ long press on the cooking zone with an active timer
- The timer is stopped.
- The system switches to the standard display.
- The cooking zone remains active on the set power level.

Time lapsed

- 10 seconds before the set time lapses, the system flashes the remaining time.
- In the last 5 seconds of the countdown an acoustic signal can be heard every second.
- The time display  and the timer button  flash.
- At the end of the set time the cooking zone is automatically deactivated (= power level )

6.6.8 Pause function

With the pause function all cooking zones can be quickly and easily deactivated temporarily. When the function is cancelled, operation resumes at the original settings.

The cooking session can be paused for a maximum of 10 minutes. Once 10 minutes have lapsed, the cooking session is automatically ended.

Activating the pause function

- ▶ Tap the pause button 
- The pause button lights up, all cooking sessions are paused and an acoustic signal is heard.
- The cooking zone indicators are dimmed.
- The pause timer is started (max. 10 min).

i During the pause, the fan function is not interrupted. Any active short-time timers stay the same. Active cooking zone timers are stopped.

Deactivating the pause function



- ▶ Long press on the pause button 
- The pause button is dimmed.
- The cooking zone indicators light up.
- All cooking sessions are resumed at the power levels set prior to the pause.
- Active cooking zone timers are resumed.

6.6.9 Heat retention function (only on Pure)

The warming function enables meals that have already been cooked to be kept warm at a lower temperature without any risk of burning.

- The maximum duration for the heat retention function is preset to 8 hours.

Activating the heat retention function

- ▶ Tap the required cooking zone
- The additional cooking zone functions appear.
- ▶ Tap the heat retention button 
- The heat retention level is activated.
-  is displayed in the cooking zone display.
- The heat retention symbol  is shown next to the cooking zone.

Deactivating the heat retention function

- ▶ Tap the required cooking zone
 - ▶ Tap the heat retention button 
 - or
 - ▶ swipe right down to the bottom (power level 0)
 - The heat retention function is deactivated.
- Setting a power level also deactivates the heat retention function.

6.6.10 Variable heat retention function (only on X Pure)

Depending on the application or food used, it is possible to choose from 3 warming levels at different temperatures:



heat retention level	Symbol	Temperature
1 (melting)	–	≈ 42 °C
2 (keeping warm)	≡	≈ 74 °C
3 (simmering)	≡	≈ 94 °C

Tab. 6.8 Heat retention levels

- The maximum duration of the heat retention function is limited to 8 hours.

i In practice the temperatures of the warming levels may vary slightly as they are influenced by the cookware, the amount of food and the different heating technologies. The temperatures can also vary due to the influence of the cooktop extractor.



Activating the heat retention function

- ▶ Tap the required cooking zone
- ▶ Tap the heat retention button 
- The first heat retention level (–) is displayed.
- The warming symbol  is shown next to the cooking zone.

Increasing or reducing the heat retention level

- ▶ Swipe upwards or downwards until the required heat retention level is reached

or

- ▶ tap  or  until the required warming level is reached

Deactivating the heat retention function

- ▶ Tap the cooking zone on which the heat retention function is activated
- ▶ Swipe downwards
- or
- ▶ long press on the heat retention button 
- The heat retention function is deactivated.
- The residual heat indicator H appears in the cooking zone display if necessary.

6.6.11 Bridging function (only on X Pure)

With the bridging function two cooking zones can be combined to form one large cooking zone. The power for the combined zones is then adjusted by a single operating control. Power adjustment takes place simultaneously (both cooking zones are operated on the same power level).

The bridging function is suitable for heating food, e.g. in a roaster.

- i** If both cooking zones are active before the bridging function is activated, the lower power level is adopted. If cooking zone timers are active, the lower timer value is adopted.
- i** If no suitable cookware is detected (pan size recognition) within 10 seconds with the bridging function active, the bridging function will be disabled and the cooking zones will be deactivated.

Activating the bridging function

- ▶ Tap both cooking zones at the same time.
 - The bridging function is now active.
 - The dividing line between the cooking zones on the operating panel disappears and the additional cooking-zone functions are displayed.
 - Both cooking zone indicators show the same power level.
 - Changes to the power level now apply simultaneously to both cooking zones.
 - Active additional cooking-zone functions are adopted and apply to both cooking zones (dual display).

Deactivating the bridging function

- ▶ Long press on one of the two cooking zones with an active bridging function

or

- ▶ tap the cooking zones with an active bridging function simultaneously.
 - The bridging function is deactivated.
 - The dividing line between the cooking zones on the operating panel reappears.
 - The power levels are set to 0
 - If a cooking zone timer was active, it is deactivated.

- If cookware is only detected on one of the two cooking zones, the bridging function is cancelled after ten seconds and the empty cooking zone is deactivated.

6.6.12 Automatic bridging function (only on X Pure)

If a large enough cooking pot or roaster is placed on the two cooking zones that are one behind the other, they will automatically be combined to form one large cooking zone. The bridging function does not need to be activated manually.

- i** If the permanent pan size recognition is switched on (see “7.7 Menu item 7: Permanent pan size recognition”), the automatic bridging function is also activated.

6.7 Safety features

6.7.1 Child lock

The child lock prevents the appliance from being switched on accidentally.

- After switching on the appliance, the lock symbol lights up in the operating panel display .

Permanently activating/deactivating the child lock

see “7.2 Menu item 2: Childproofing feature”

Deactivating the child lock for a cooking session

- ▶ Long press on the lock button .
- ▶ Swipe downwards
 - The standard display lights up and the operating panel is reactivated.

6.7.2 Residual heat indicator

If a cooking zone is still hot after switching off, there is a risk of burns or fire. While H is displayed for a cooking zone (residual heat indicator), do not touch the cooking zone or place any heat-sensitive objects on top of it.

- H shown at 100% brightness: very high temperature.
- H shown at 50% brightness: high temperature. The display goes out after a sufficient cooling time (temperature <math><55^{\circ}\text{C}</math>).

6.7.3 Safety shut-down

Cooktop extractor

The cooktop extractor switches to automatic mode after 120 min if there has been no input or changes to the power level.

Cooktops

Each cooking zone is automatically switched off after a predefined operating time in which the power level has not been changed. 3 levels are available to set the time until safety shut-down.

- Safety shut-down is preset to level 2.
- The level can be changed in the user menu.

Power levels	Safety shut-down after hrs:min		
	Level 1	Level 2	Level 3
1	12:00	8:24	6:00
2	10:00	6:24	4:00
3	9:00	5:12	2:30
4	8:00	4:12	2:00
5	6:00	3:18	1:30
6	4:00	2:12	1:00
7	4:00	2:12	1:00
8	3:00	1:48	00:45
9	2:00	1:18	00:30
P	00:05	00:05	00:05

Tab. 6.9 Safety shut-down on the different power levels

heat retention level	Safety shut-down after hrs:min		
	Level 1	Level 2	Level 3
	12:00	8:00	4:00

Tab. 6.10 Safety shut-down of the different heat retention levels

- ▶ Switch the cooking zone back on if you want to put the cooking zone back into operation.

6.7.4 Overheating protection

- i** In the event of overheating, the cooktop power is reduced or the appliance is switched off completely.

The appliance is fitted with overheating protection. The overheating protection can be triggered if:

- cookware is heated up empty;
- oil or fat is heated on high power;
- a hot cooking zone is switched on again after a power cut.

Whilst the overheating protection is active, one of the following steps is taken:

- the activated power setting is switched back to the previous level;
- the power setting P can no longer be switched on;
- the set power level is reduced;
- the cooktop switches off completely.

After a sufficient cooling period, the cooktop can be used again in full.

7 User menu

Certain functions can be set in the user menu.

- i** The menu can only be called up if all cooking zones and the cooktop extractor are inactive. In addition, there must be no residual heat.

Calling up the user menu

- ▶ Switch on the appliance by pressing the power button .
- If start-up is successful, the standard display will appear in the operating panel.
- ▶ Long press on the multi-function display.
- The menu is called up and the first menu item is displayed.

Navigating the user menu

- ▶ Tap the multi-function display
- The system moves to the next menu item.
- The system automatically adopts and saves set values when you move to another menu item or close the menu.

Closing the user menu

- ▶ Long press on the multi-function display.
- or
- ▶ switch off the appliance by pressing the power button .
- The menu is closed and the appliance is switched off.

User menu overview

Menu item/Description/Selection area	Factory setting
1 Volume of the acoustic signals (0–9)	4
2 Childproofing feature (On/Off)	Off
3 Show filter status (reset filter service display)	
4 Duration of the automatic after-run function (10, 15, 20 min.)	20 min
5 Touch zone reaction speed (1 slow, 2 medium, 3 fast)	2
6 LED test	
7 Permanent pan size recognition	Off
8 Software/hardware version	
9 Safety shut-down (1 long, 2 medium, 3 short)	2
A Super simple mode	Off
0 Reset to factory settings	

Tab. 7.1 User menu overview

7.1 Menu item 1: Volume of the acoustic signals

- i** In the event of an error message the acoustic signal is always heard at full volume and cannot be changed.
- i** The acoustic signal when switching on or off is always set to at least volume level 4.
- i** The current set volume is shown in the rear, left-hand cooking zone display when the menu item is called up.

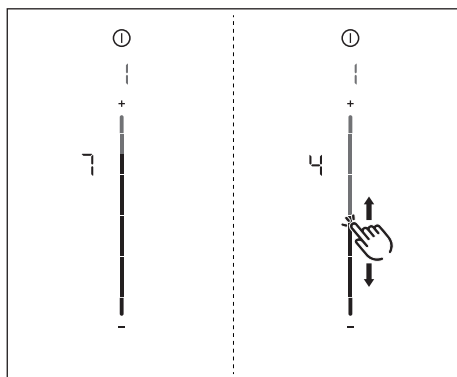



Fig. 7.1 Menu item 1: Volume of the acoustic signals

Setting the acoustic signal volume:

- ▶ Swipe  upwards or downwards until the required volume is reached.
- ▶ Move to another menu item or close the menu.

7.2 Menu item 2: Childproofing feature

- i** With menu item 2 the childproofing feature can be permanently switched on or off. This setting is adopted for each new cooking session.

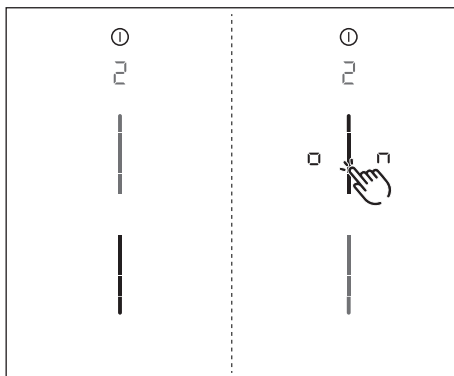





Fig. 7.2 Menu item 2: Childproofing feature

Permanently activating the childproofing feature

- ▶ Tap the top slider segment 
-  is displayed.
- ▶ Move to another menu item or close the menu.
- The childproofing feature is permanently activated.

Permanently deactivating the childproofing feature

- ▶ Tap the bottom slider segment 
- ▶ Move to another menu item or close the menu.
- The childproofing feature is permanently deactivated.

7.3 Menu item 3: Showing the filter status and resetting filter service display

- i** If menu item 3 is called up, the filter status will be automatically shown (only in recirculation mode).

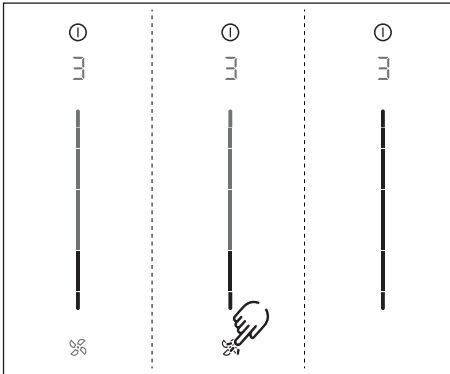



Fig. 7.3 Menu item 3: Filter status

Resetting the filter service display:

- ▶ Long press on the fan button .
- All slider elements are once again displayed at 100% brightness.
- The filter service display F no longer appears when the cooktop extractor is switched on.
- ▶ Move to another menu item or close the menu.

7.4 Menu item 4: Duration of the automatic after-run function

- i** The duration of the automatic after-run function can be set using menu item 4.

There are three times to choose from:

- 20 minutes
- 15 minutes
- 10 minutes

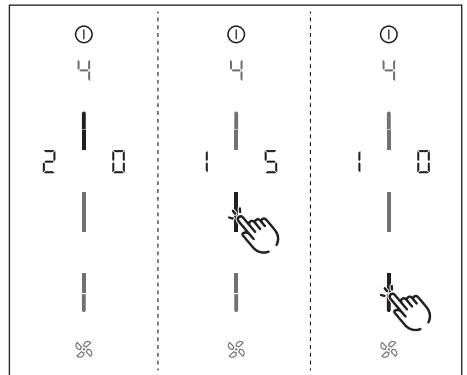



Fig. 7.4 Menu item 4: Duration of the automatic after-run function

- The current duration is displayed for 2 seconds.

Selecting the duration of the automatic after-run function:

- ▶ Tap the corresponding slider segment .
- ▶ Move to another menu item or close the menu.

7.5 Menu item 5: Touch zone reaction speed

i The reaction speed of the touch zones can be set using menu item 5.

- Reaction speed 1: slow
- Reaction speed 2: medium
- Reaction speed 3: fast

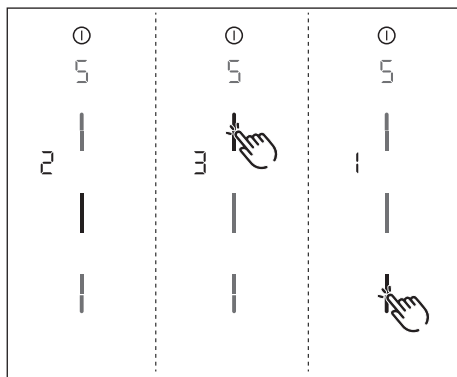



Fig. 7.5 Menu item 5: Reaction speed

- The current reaction speed is displayed.

Selecting the reaction speed:

- ▶ Tap the corresponding slider segment 
- ▶ Move to another menu item or close the menu.

7.6 Menu item 6: LED test

i With menu item 6 all LEDs in the individual touch zones can be tested to ensure that they are working.

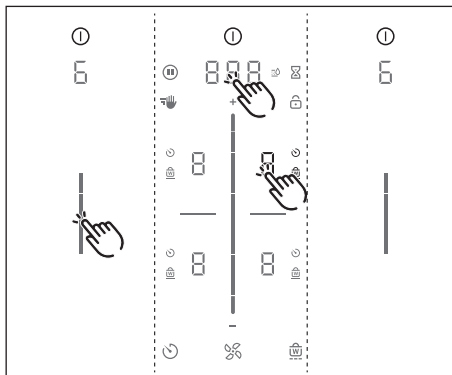



Fig. 7.6 Menu item 6: LED test

Starting the LED test

- ▶ Tap the slider zone 
- All indicators are displayed at 50% brightness.
- ▶ Tap any indicator you wish.
- The selected indicator will be displayed at 100% brightness for one second.
- Any other indicators can be tested by touch as required.

Ending the LED test

- The LED test will be automatically ended when there has been no activity for 5 seconds.
- or
- ▶ Long press on the multi-function display.
 - The LED test is ended and the appliance is switched off.

7.7 Menu item 7: Permanent pan size recognition

- i** With menu item 7 the permanent pan size recognition can be permanently switched on or off.

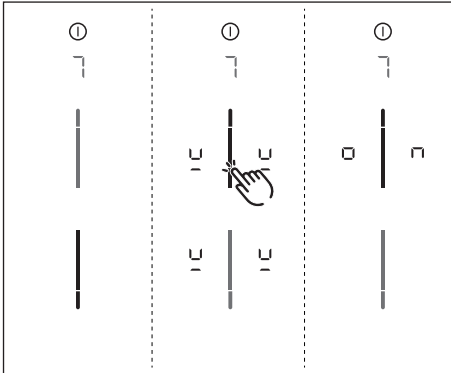





Fig. 7.7 Menu item 7: Permanent pan size recognition

Activating permanent pan size recognition

- ▶ Tap the top slider segment 
- The pan size recognition symbol  is displayed on all cooking zones for one second.
-  is displayed.
- ▶ Move to another menu item or close the menu.

Deactivating permanent pan size recognition

- ▶ Tap the bottom slider segment 
- ▶ Move to another menu item or close the menu.

7.8 Menu item 8: Show software/hardware version

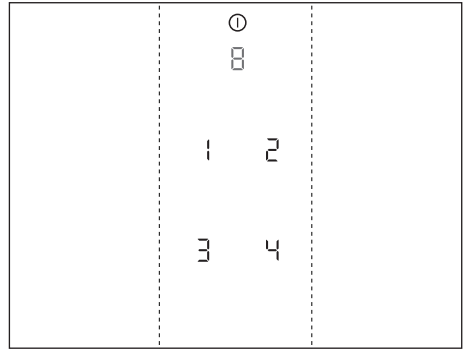

Fig. 7.8 Menu item 8: Software/hardware version

- The software/hardware version is shown via the four 7-segment cooking zone indicators.
- ▶ Move to another menu item or close the menu.

7.9 Menu item 9: Safety shut-down

i The time span (level) until automatic safety shut-down of the cooking zones can be selected using menu item 9.

- Level 1: long time span until automatic safety shut-down
- Level 2: medium time span until automatic safety shut-down
- Level 3: short time span until automatic safety shut-down

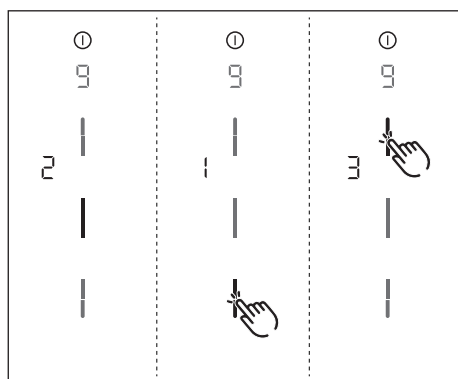



Fig. 7.9 Menu item 9: Safety shut-down

- The current level is displayed.

Selecting the level:

- ▶ Tap the corresponding slider segment 
- ▶ Move to another menu item or close the menu.

7.10 Menu item A: super simple mode

i In super simple mode certain additional functions are deactivated and their indicators are faded out.

The following additional functions are deactivated in super simple mode:

- cooking zone timer
- short-time timer (egg timer)
- cleaning lock (wipe function)
- control lock
- heat retention function
- pause function

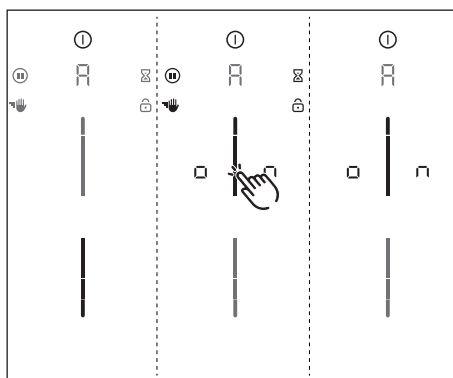



Fig. 7.10 Menu item A: super simple mode

Activating super simple mode

- ▶ Tap the top slider segment 
- The additional function indicators, which were deactivated, flash and fade.
-  is displayed.
- ▶ Move to another menu item or close the menu.
- The additional functions are permanently deactivated and are not displayed.

7.11 Menu item 0: Reset to factory settings

- i** Menu item 0 enables all settings in the user menu to be reset to the factory settings.

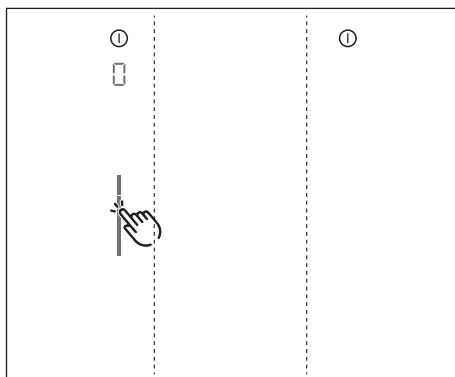



Fig. 7.11 Menu item 0: Factory settings

Resetting to factory settings

- ▶ Long press on the slider zone 
- After resetting, the appliance is switched off.

8 Cleaning and maintenance

- ▶ Observe all safety and warning information (see “2 Safety”).
- ▶ When conducting scheduled cleaning and maintenance, ensure that the cooktop and cooktop extractor are fully switched off and cooled so as to prevent injury.
- Regular cleaning and maintenance ensures long service life of the product and optimal function.
- ▶ Adhere to the following cleaning and maintenance cycles:

Component	Cleaning cycle
Operating panel	Immediately after every soiling
Cooktop	Clean with conventional glass ceramic detergents immediately after soiling and on a weekly basis
Cooktop extractor	weekly
Air inlet nozzle and stainless steel filter	after cooking very greasy dishes; at least once a week, when the fan power level indicator shows F by hand or in the dishwasher (at 65°C max.); clean stainless steel surfaces in the polishing direction only!
Air guiding housing	Every 6 months or when replacing the activated charcoal filter
Activated charcoal filter (with recirculation only)	replace if odours have built up, extraction power is dwindling or the fan power level indicator shows F

Tab. 8.1 Cleaning cycles

8.1 Cleaning agents

- i** Due to the use of aggressive cleaning agents and abrasion caused by the pot bases the surface will become damaged and dark stains will occur.

To clean the cooktop, you need a special glass ceramic scraper and suitable cleaning agents.

- ▶ Never use steam cleaners, abrasive sponges, scouring pads or chemically aggressive cleaning agents (e.g. oven cleaner spray).
- ▶ Make sure that the cleaning agent does not contain any sand, soda, acids, lyes or chloride.

For the air inlet nozzle and grease filter

- ▶ Do not use any aggressive cleaning agents or agents containing acid or lye.

8.2 Cooktop and extractor care

- ▶ Never use the cooktop as a work or storage surface.
- ▶ Do not push or pull cookware over the cooktop.
- ▶ Always lift pots and pans.
- ▶ Keep the cooktop and extractor clean.
- ▶ Remove any dirt immediately.
- ▶ Only use cookware suitable for glass ceramic cooktops (see “5.4.1 Suitable cookware”).

8.3 Cleaning the cooktop

- i** When the cooktop extractor is in use the air inlet nozzle must be fitted so that no small or light objects such as fabric or paper cleaning cloths can be sucked in.

- ▶ Make sure that the cooktop is switched off.
- ▶ Wait until all cooking zones are cold.
- ▶ Remove all coarse dirt and food residues from the cooktop using a glass ceramic scraper.
- ▶ Apply the cleaning agent to the cold cooktop.
- ▶ Spread the cleaning agent using kitchen roll or a clean cloth.
- ▶ Wipe the cooktop clean with a damp cloth.
- ▶ Dry the cooktop with a clean cloth.

If the cooktop is hot:

- ▶ Remove stubborn residues of plastic, aluminium foil, sugar or sweet dishes from the hot cooking zone immediately using a glass ceramic scraper to prevent burning.

Heavy soiling

- ▶ Remove heavy soiling and marks (limescale marks, mother-of-pearl-like shiny marks) using cleaning products while the cooktop is still warm.
- ▶ Wipe off any food that boils over with a damp cloth.
- ▶ Remove any remaining dirt with the glass ceramic scraper.
- ▶ Always remove any seeds, crumbs or similar that fall onto the cooktop during cooking immediately to prevent the surface getting scratched.

Any changes in colour or glossy spots do not mean that the cooktop is damaged. They do not affect the functionality of the cooktop or the stability of the glass ceramic panel.

Changes in the colour of the cooktop are the result of residues which have not been removed and have burnt on.

Glossy spots are the result of wear by the pan base, especially if aluminium-based cookware or unsuitable cleaning agents are used. These are difficult to remove.

8.4 Cleaning the cooktop extractor

The air inlet nozzle and stainless steel grease filter absorb the greasy particles from cooking vapours.

- ▶ Make sure that the cooktop and cooktop extractor are switched off.
- ▶ Wait until the fan indicator shows □ _
- ▶ Clean the cooktop extractor in accordance with the cleaning cycles.
- ▶ Clean the surfaces of the extraction system using a soft, damp cloth, detergent or a mild window cleaning agent.
- ▶ Soften dried on dirt using a damp cloth (do not scrape it off!).

8.4.1 Removing the components

Removing the X Pure air inlet nozzle

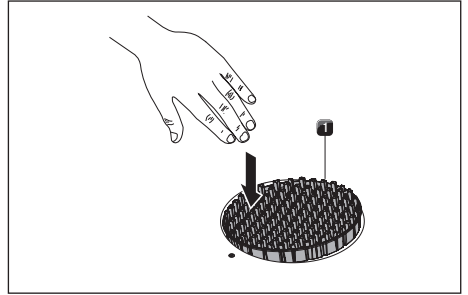

Fig. 8.1 Removing air inlet nozzle PUXA, PUXU

- [1] Air inlet nozzle

Prerequisite:

The fan level indicator shows □ _

- ▶ Tilt the air inlet nozzle [1] from its horizontal position.
- ▶ Remove the air inlet nozzle [1] with your other hand.

Removing the Pure air inlet nozzle

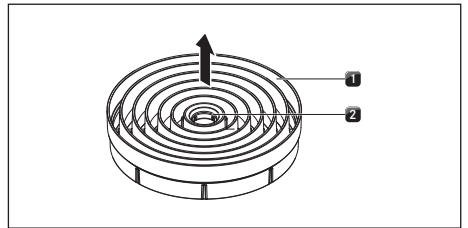

Fig. 8.2 Removing air inlet nozzle PURA, PURU

- [1] Air inlet nozzle
[2] Access opening

Prerequisite:

The fan level indicator shows □ _

- ▶ Reach into the access opening [2] of the air inlet nozzle [1] with your finger.
- ▶ Pull the air inlet nozzle [1] up and out.

Removing the stainless steel grease filter

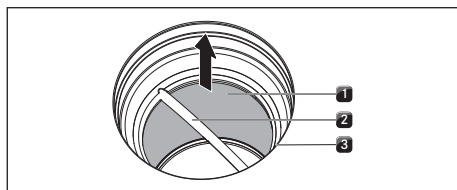

Fig. 8.3 Removing the stainless steel grease filter

- [1] Stainless steel grease filter
- [2] Handle
- [3] Inlet opening

- ▶ Take hold of the stainless steel grease filter by the handle [2].
- ▶ Pull the stainless steel grease filter [1] up and out of the suction opening [3].

8.4.2 Cleaning the air inlet nozzle and stainless steel grease filter

- i** If it is no longer possible to clean the stainless steel grease filter completely, it must be replaced (see "12 Warranty, technical service, spare parts, accessories").

Manual cleaning

- ▶ Use a cleaner and degreaser in one.
- ▶ Rinse the air inlet nozzle and stainless steel grease filter with hot water.
- ▶ Use a soft brush to clean the air inlet nozzle and stainless steel grease filter.
- ▶ After cleaning, rinse the air inlet nozzle and stainless steel grease filter well.

Cleaning in the dishwasher

- ▶ Remove coarse food residues from the stainless steel filter
- ▶ Rinse the air inlet nozzle and stainless steel grease filter with a rinsing programme at a maximum of 65°C.

- i** To prevent water from dripping into the appliance, it is recommendable to shake the nozzle well upon removal from the dishwasher and, if necessary, to dry it with a tea towel.

8.4.3 Fitting the components

Inserting the stainless steel grease filter

- ▶ Take hold of the stainless steel grease filter by the handle [2].
- ▶ Insert the stainless steel grease filter [1] in the inlet opening [3]. A lock is not provided or necessary.

Inserting the air inlet nozzle

- ▶ Insert the air inlet nozzle in the inlet opening.
- ▶ Make sure it is positioned correctly.

8.4.4 Removing liquids from the appliance

Any liquids that flow into the appliance through the inlet opening are caught by the stainless steel grease filter (up to 150 ml) and in the air guiding housing. Do the following:

- ▶ Switch off the fan and deactivate the after-run function (see "6.5 Operating the cooktop extractor").
- ▶ Remove the air inlet nozzle and stainless steel grease filter.
- ▶ Empty the stainless steel grease filter.
- ▶ Check whether any liquid has gathered in the base of the air guiding housing.
- ▶ If necessary, wipe the liquid up from the housing base from above through the inlet opening using a sponge or cloth.
- ▶ Clean the air guiding housing.
- ▶ To dry the odour filter and duct parts respectively, switch on the cooktop extractor at a minimum power level of 5.
- After 120 minutes the cooktop extractor will automatically switch to the automatic after-run function.

8.5 Cleaning the air guiding housing

Grease particles and limescale residues from cooking vapours can settle on the surface of the air guiding housing. For this reason, regular cleaning is essential.

The air guiding housing can be found on the bottom of the cooktop inside the floor unit.

Opening the air guiding housing.

- ▶ Make sure that the cooktop and cooktop extractor are switched off.
- ▶ Wait until the fan indicator shows \square .
- ▶ Remove the air inlet nozzle and stainless steel grease filter.
- ▶ Inside the inlet opening pull the filter replacement cover out of the filter housing opening (to remove the filter replacement cover see Fig. 8.11).

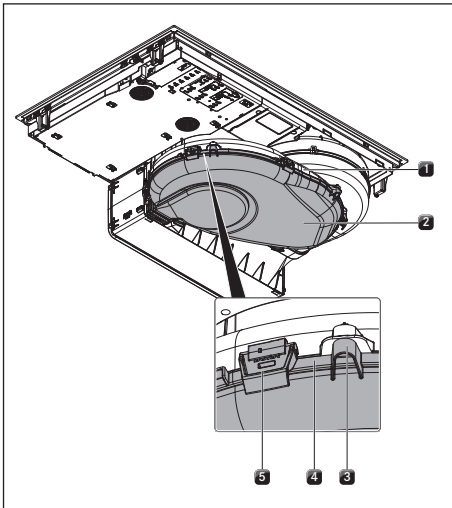

Fig. 8.4 Air guiding housing

- [1] Air guiding housing
- [2] Housing base
- [3] Spigot
- [4] Sealing groove
- [5] Lock

- ▶ Hold the housing base [2] with one hand.

- ▶ Release the 6 locks [5] around the edge of the base.
- ▶ Remove the housing base [2].
- ▶ Clean the air guiding housing [1] and the housing base [2] with a mild cleaning agent.

Closing the air guiding housing

- ▶ Position the housing base [2] under the air guiding housing [1] with the help of the 3 spigots [3].
- ▶ Push the housing base [2] upwards into the sealing groove [4].
- ▶ Close the 6 locks [5].
- ▶ Check that the housing base is positioned correctly.
- ▶ Inside the inlet opening push the filter replacement cover until it comes to a stop in the filter housing opening (to insert the filter replacement cover see Fig. 8.11).
- ▶ Check that the filter replacement cover is positioned correctly.
- ▶ Insert the stainless steel grease filter and the air inlet nozzle.

8.6 Replacing the activated charcoal filter

An activated charcoal filter will only be fitted with the stainless steel grease filter if the cooktop extractor is used in recirculation mode. The activated charcoal filter absorbs cooking odours that arise during cooking.

- i** The activated charcoal filter must be replaced when the fan indicator shows F (filter service display). You can obtain the activated charcoal filter PUAKE from your specialised retailer or by contacting BORA via the website at www.bora.com/filter.

- ▶ Make sure that the cooktop and cooktop extractor are switched off.
- ▶ Wait until the fan indicator shows \square .

Removing the activated charcoal filter

- ▶ Remove the air inlet nozzle and stainless steel grease filter.

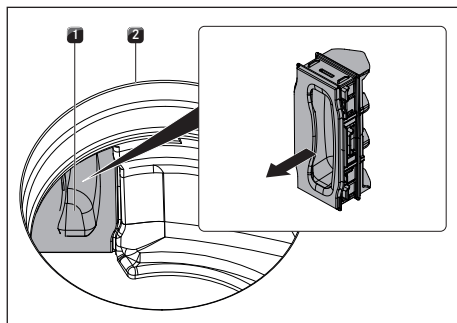

Fig. 8.5 Remove the filter replacement cover

- [1] Filter replacement cover
- [2] Inlet opening

- ▶ Inside the inlet opening [2] pull the filter replacement cover [1] out through the opening in the filter housing.

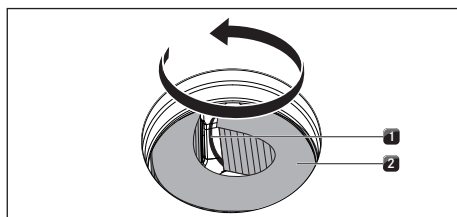

Fig. 8.6 Removing the activated charcoal filter from the filter housing

- [1] Grip strap
- [2] Activated charcoal filter

- ▶ Take hold of the activated charcoal filter [2] by the grip strap [1] and pull it out as far as possible through the filter housing opening.

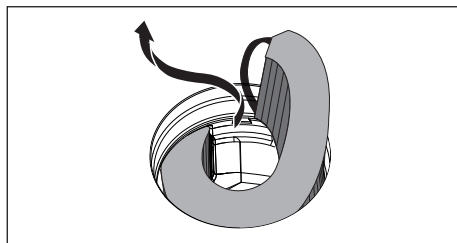

Fig. 8.7 Removing the activated charcoal filter through the inlet opening

- ▶ Take hold of the end of the activated charcoal filter and pull upwards and towards the left until it is completely out of the inlet opening.

Inserting the activated charcoal filter

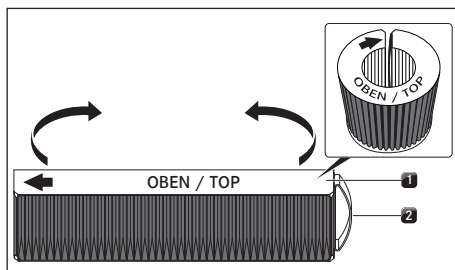

Fig. 8.8 Activated charcoal filter

- [1] Activated charcoal filter
- [2] Grip strap

- ▶ Remove the packaging from the activated charcoal filter [1].
- ▶ Position the activated charcoal filter correctly with the help of the printed symbols (arrow left, grip strap [2] right).
- ▶ Hold the activated charcoal filter at both ends.
- ▶ Bend the activated charcoal filter into a cylindrical shape so that both ends of the filter are opposite each other.

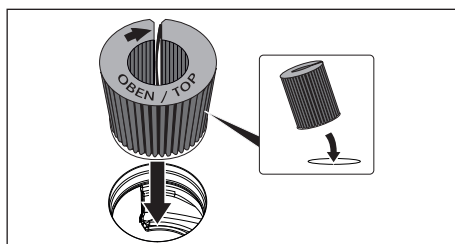

Fig. 8.9 Inserting the activated charcoal filter through the vent opening

- ▶ Tilt the activated charcoal filter towards you slightly and insert it through the inlet opening.
- ▶ Guide the left end of the filter into the opening in the filter housing.

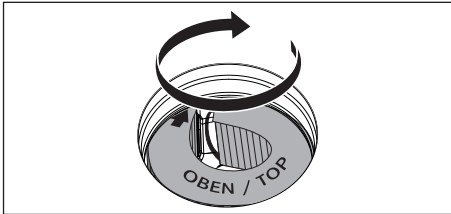

Fig. 8.10 Placing the activated charcoal filter in the end position

- ▶ Push the activated charcoal filter into the filter housing until it will go no further (to do this, you can place one finger between the slats and gradually push the filter into the housing).
- The end position of the activated charcoal filter is reached when the filter has been fully pushed inside the filter housing.

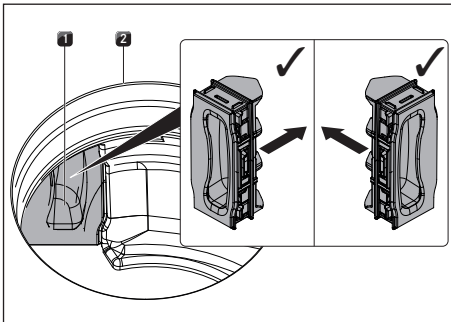

Fig. 8.11 Inserting the filter replacement cover

- [1] Filter replacement cover
- [2] Inlet opening

- ▶ Inside the inlet opening push the filter replacement cover until it comes to a stop in the filter housing opening.
- ▶ Check that the filter replacement cover is positioned correctly.
- ▶ Insert the stainless steel grease filter and the air inlet nozzle.
- ▶ Reset the filter status indicator (see “7.3 Menu item 3: Showing the filter status and resetting filter service display”).

9 Troubleshooting

i You can often resolve faults and errors that can occur in day-to-day operation yourself. That way you save time and money as you don't need to call out customer services.

► Observe all safety and warning information (see "2 Safety").

Operating situation	Cause	Remedy
The cooktop or the fan cannot be switched on.	The fuse or automatic circuit breaker of the electrical wiring system in the apartment and/or house is defective.	Replace the fuse. Switch the automatic circuit breaker back on.
	The fuse/automatic circuit breaker trips several times.	Contact the BORA Service Team.
	The power supply is disconnected.	Have a specialist electrician inspect the power supply.
Build-up of odours when new cooktop extractor is in operation.	This is normal on brand-new appliances.	Odours stop forming after a few operating hours.
⏸ is displayed in the cooking zone display.	No or unsuitable cookware on the cooking zone.	Use suitable cookware. Select the cookware size depending on the cooking zone (see "5 Appliance description").
The lock symbol is brighter than the other indicators.	The childproofing feature is activated.	Switch off the childproofing feature.
A cooking zone or the entire cooktop switches off automatically.	The maximum cooking zone operating time has been exceeded.	Put the cooking zone back into operation.
The power setting is automatically shut off prematurely.	The overheating protection has tripped.	see "6.7.4 Overheating protection"
The cooktop cooling fan continues to run when the cooktop has been switched off.	The cooling fan runs until the cooktop has cooled.	Wait until the cooling fan switches off automatically.
The extraction performance of the cooktop extractor has decreased.	The grease filter is extremely dirty.	Clean or replace the grease filter.
	The activated charcoal filter is extremely dirty (with PUXU and PURU only).	Insert a new activated charcoal filter (see "8.6 Replacing the activated charcoal filter").
	There is an object in the air guiding housing (e.g. cleaning cloth).	Remove the object.
E is shown in the fan display.	Home In not authorised.	Open the window.
	The safety device is defective.	Contact the BORA Service Team.
E is shown in the cooking zone	The overheating protection has tripped.	see "6.7.4 Overheating protection"
E is displayed. E in the fan display, E in the rear cooking zones.	Object on the operating panel.	Remove the object from the operating panel.
	The operating panel is dirty.	Clean the operating panel.
EB is shown in the fan display	Use of a phase-separating window contact switch.	Open the window.
	The cooktop extractor is defective or a cable connection has become loose.	Contact the BORA Service Team.
F is shown in the fan display (only with PUXU and PURU).	End of activated charcoal filter service life reached.	Insert a new activated charcoal filter (see "8.6 Replacing the activated charcoal filter").

Tab. 9.1 Resolving a fault

Faults and errors not covered:

- ▶ Switch off the appliance.
- ▶ Contact the BORA Service Team (see “12 Warranty, technical service, spare parts, accessories”) and enter the error number displayed and the appliance type.

10 Installation

- ▶ Observe all safety and warning information (see “2 Safety”).
- ▶ Follow the enclosed manufacturer’s information

10.1 General installation instructions

- i** The power supply cable must be provided by the customer.
- i** The appliance must not be installed above cooling devices, dishwashers, stoves, ovens, washing machines or dryers.
- i** The contact surface of the worktops and wall sealing strips must be made of a heat-resistant material (up to approx. 100°C).
- i** Worktop cut-outs must be moisture-sealed using suitable means and, where necessary, fitted with a thermal insulator.
- i** The integrated cooktop extractor must not be used with other cooktops.

General installation instructions for cooktops

- i** To ensure that the cooktops perform optimally at all times, there must be sufficient ventilation beneath the cooktops.
 - i** The performance of the cooktops is affected or the cooktops overheat if the warm air beneath the cooktops cannot escape.
 - i** If a cooktop overheats, the power is automatically reduced or the cooktop is switched off completely (see “6.7.4 Overheating protection”).
 - i** If cable protection (false floor) is planned beneath the appliance, this must be fitted so it does not obstruct ventilation.
- ▶ Make sure that the area below the cooktop has a sufficient air supply.

10.1.1 Simultaneous operation of the cooktop extractor in the exhaust air mode and a fireplace dependent upon the air supply in the room

- i** National and regional laws and regulations must be observed with regard to the exhaust duct design.
- i** A sufficient air supply must be ensured

Fireplaces that depend on the air in the room (e.g. gas, oil, wood or coal-fired heaters, continuous-flow water heaters, instantaneous water heaters) draw in air from the room in which they are installed and release the exhaust fumes into the outside air via an exhaust system (e.g. chimney).

If the cooktop extractor is used in exhaust air mode, it draws in air from the room in which it is installed as well as from neighbouring rooms. If there is insufficient air supply, low pressure will occur. Toxic gases could be drawn out of the chimney or extraction ducting and back into the room.

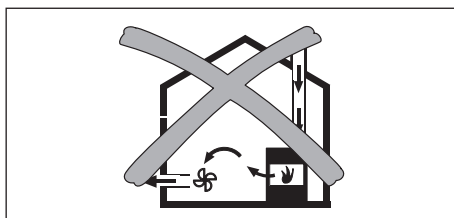

Fig. 10.1 Exhaust air installation – not permitted

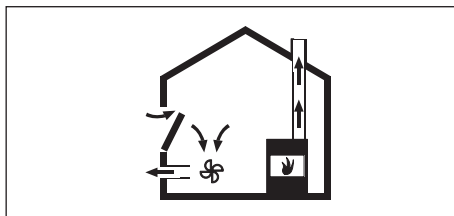

Fig. 10.2 Exhaust air installation – correct

- ▶ If simultaneously operating both a fireplace and the cooktop extractor in the same room, ensure that:
 - the maximum low pressure is 4 Pa (4 x 10–5 bar);
 - a safety device (e.g. window contact switch, low pressure warning device) is used to ensure that a sufficient supply of fresh air is guaranteed;
 - the exhaust air is not channelled into a chimney that is used for exhaust gases of appliances operated with gas or other combustibles;
 - the installation is checked and approved by an authorised certified engineer (e.g. heating engineer).

i If the cooktop extractor is used exclusively in recirculation mode, operation with an open fireplace is possible without any additional safety measures.

10.1.2 Home In module PUHIM (optional)

Via this additional interface it is possible to establish a connection to other systems and, for example, a window contact switch or low pressure warning device can be connected. The module is to be integrated in the cooktop.

- i** The BORA Pure Home In module PUHIM is available as an accessory.
- i** The BORA window contact switch UFKS is available as an accessory.

10.2 Scope of delivery

Scope of delivery: PUXA, PUXU, PURA, PURU	Quantity
Cooktop with integrated cooktop extractor	1
Air inlet nozzle	1
Stainless steel grease filter	1
Operating and installation instructions	1
Installation clamps	4
Sealing tape	1
Height adjustment plate set	1
Bag containing various small parts for assembly	1
Additional scope of delivery: PURU, PUXU	
Activated charcoal filter	1
Template for back panel cut-out	1

Tab. 10.1 Scope of delivery

Checking the scope of delivery

- ▶ Make sure the delivery is complete and check it for damage.
- ▶ If there are any missing or damaged parts, please notify the BORA After Sales Service immediately.
- ▶ Do not under any circumstances install parts which are damaged.
- ▶ Dispose of transport packaging in the proper manner (see “11 Decommissioning, disassembly and disposal”).

10.3 Tools and aids

The following special tools, among others, are required to correctly install the cooktop:

- compass saw or hand saw
- drilling template for cut-out on back panel PURU (included in scope of delivery)
- Torx 20 screwdriver
- black, heat-resistant silicone sealant

10.4 Assembly instructions

10.4.1 Installation clearances

- ▶ Observe the required clearance around the worktop cut-out.

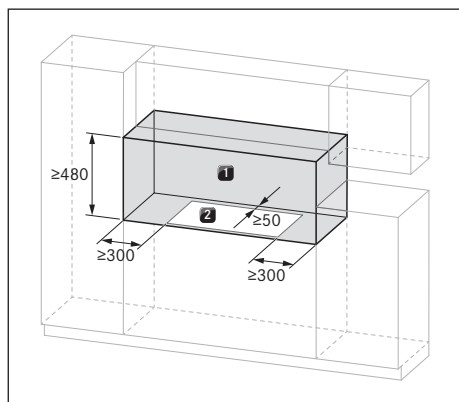

Fig. 10.3 Required clearance

- [1] Required clearance
- [2] Worktop cut-out

10.4.2 Minimum unit dimensions for X Pure (PUXA, PUXU)

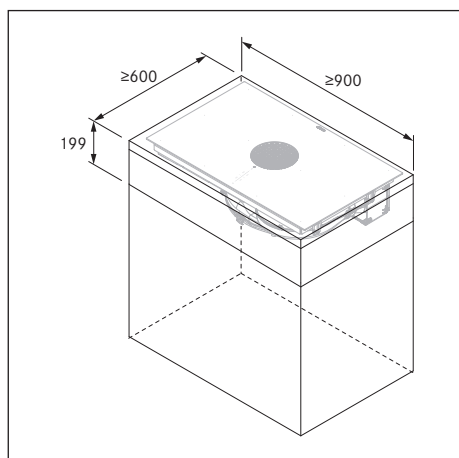

Fig. 10.4 Minimum unit dimensions for X Pure

10.4.3 Minimum unit dimensions for Pure (PURA, PURU)

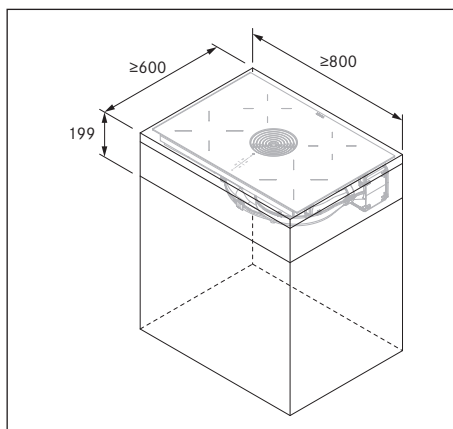

Fig. 10.5 Minimum unit dimensions for Pure

10.5 Worktop cut-out

i The minimum measurement of 50 mm from the front edge of the worktop to the worktop cut-out is a recommendation from BORA.

- ▶ Create the worktop cut-out taking into account the specified cut-out dimensions.
- ▶ Make sure that the cut surfaces of the worktops are properly sealed.
- ▶ Comply with the instructions of the worktop manufacturer.

10.5.1 X Pure cut-out dimensions (PUXA, PUXU)

X Pure flush installation (PUXA, PUXU)

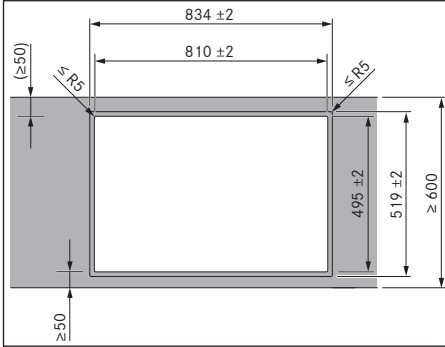

Fig. 10.6 Cut-out dimensions for flush installation

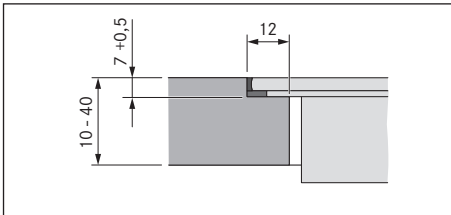

Fig. 10.7 Rebate dimensions for flush installation

X Pure surface mounting (PUXA, PUXU)

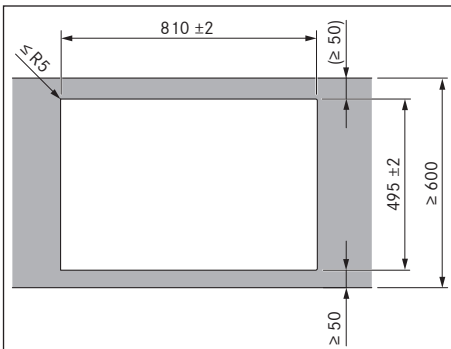

Fig. 10.8 Cut-out dimensions for surface mounting

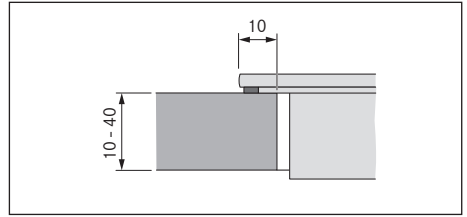

Fig. 10.9 Overlay dimensions for surface mounting

10.5.2 Pure cut-out dimensions (PURA, PURU)

Pure flush installation (PURA, PURU)

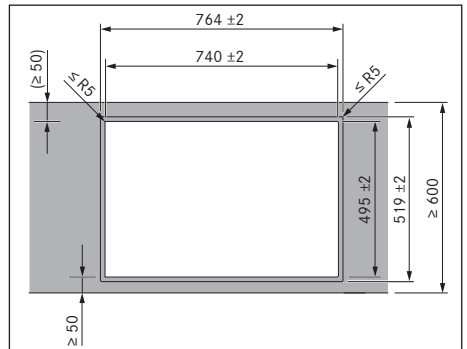

Fig. 10.10 Cut-out dimensions for flush installation

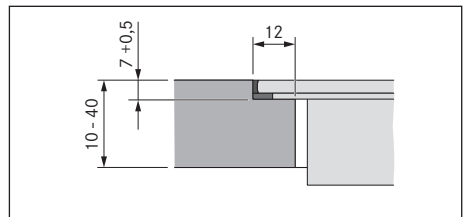

Fig. 10.11 Rebate dimensions for flush installation

Pure surface mounting (PURA, PURU)

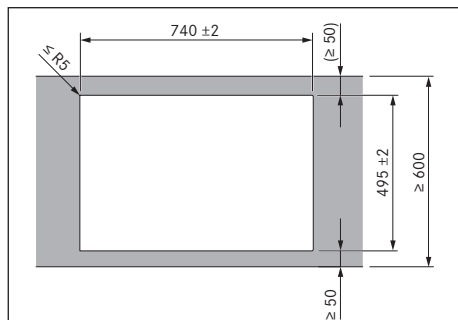

Fig. 10.12 Cut-out dimensions for surface mounting

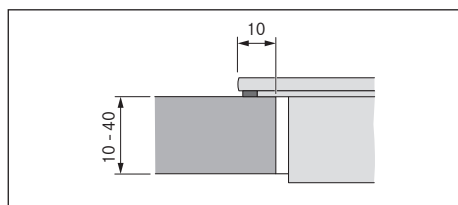

Fig. 10.13 Overlay dimensions for surface mounting

10.6 Installing the appliance in exhaust air mode (PUXA, PURA)

- i** National and regional laws and regulations must be observed with regard to the exhaust duct design.
- i** A sufficient air supply must be ensured
- i** The exhaust air must be directed to the outside by appropriate exhaust air ducts.
- i** The minimum cross-section of the air ducts must be 176 cm², which equates to a round pipe with a diameter of 150 mm or the BORA Ecotube duct system.
- i** As a general rule, with the built-in fan, a length of duct of up to 6 metres with six 90° bends, 8 metres with four 90° bends or 10 metres with two 90° bends can be installed.

i Not compatible with BORA Universal fans.

i You can find planning instructions for installation of the exhaust air ducts in the BORA planning guide.

10.6.1 Preparing kitchen units for the exhaust air model

- Cross bars on the kitchen unit in the area of the worktop cut-out may need to be removed.
- In the case of thin worktops, there must be a sufficiently rigid support plate on the unit.
- The back panel of the floor unit must be adapted for the exhaust air duct.
- A minimum clearance of 120 mm between the back panel of the unit and an adjacent kitchen unit or room wall must be observed for the air duct.
- No false floor is necessary below the cooktop. If cable protection (false floor) is planned, the following must be taken into account:
 - It must be fitted in such a way that it can be removed from below for maintenance work.
 - To ensure sufficient cooktop ventilation, a minimum distance of 15 mm to the bottom edge of the cooktop is to be observed.
- The drawers and/or shelves in the floor unit must be removable.
- For correct installation, the drawers of the floor unit must be shortened depending on the installation situation.

10.6.2 Installation dimensions

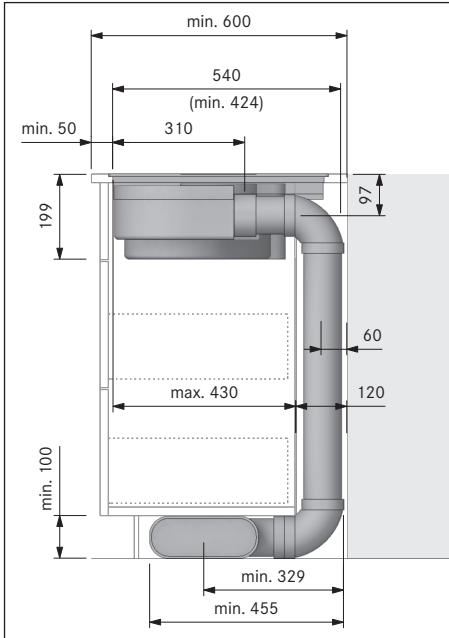

Fig. 10.14 Installation dimensions for exhaust air, worktop depth 600 mm

Adjusting the back panel of the unit

- ▶ Before installation, check the suitability of the floor unit with regard to the necessary installation dimensions for the appliance and the planned duct system.
- ▶ If necessary, adjust the position of the back panel according to the required installation dimensions.

10.6.3 Preparing the cooktop

Attaching the sealing tape

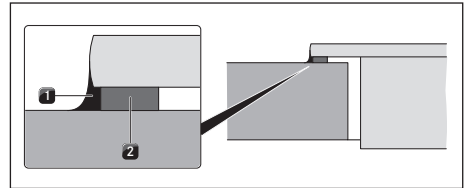

Fig. 10.15 Sealing tape in the case of surface mounting

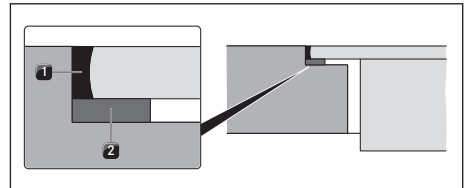

Fig. 10.16 Sealing tape in the case of flush installation

- [1] Black, heat-resistant silicone sealant
- [2] Sealing tape

- ▶ In the case of surface mounting, attach the enclosed sealing tape [2] around the outer edges of the underside of the cooktop. Do not leave any gaps.
- ▶ In the case of flush installation, attach the sealing tape [2] to the horizontal cutting edge in the worktop cut-out, even if you are sealing the cooktop with a silicone sealing compound [1] or similar.

Fitting the installation clamps

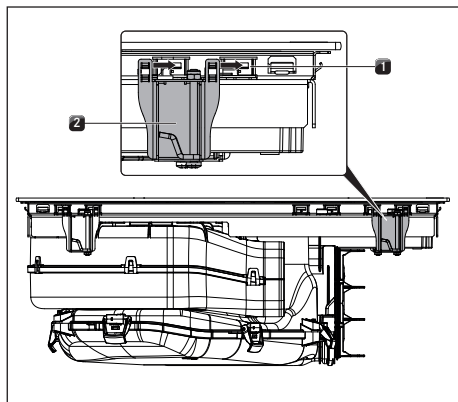

Fig. 10.17 Fitting the installation clamps

- [1] Retaining brackets
- [2] Installation clamps

i 2 installation clamps must be fitted to each side of the cooktop.

- ▶ Push 2 installation clamps [2] onto each side of the cooktop until they come to a stop in the retaining brackets [1] provided.

10.6.4 Inserting the cooktop

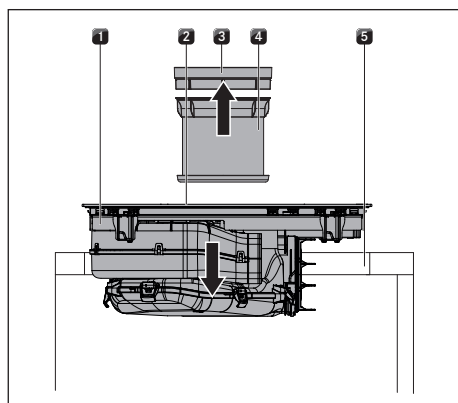

Fig. 10.18 Inserting the cooktop

- [1] Cooktop
- [2] Inlet opening
- [3] Air inlet nozzle
- [4] Stainless steel grease filter
- [5] Worktop cut-out

- ▶ Before inserting the cooktop, remove the air inlet nozzle [3] and the stainless steel grease filter [4].
- ▶ Use the inlet opening [2] as a handle during insertion.
- ▶ Keep the cooktop [1] straight as you lift it into the worktop cut-out [5].
- ▶ Insert the cooktop [1] into the centre of the worktop cut-out [5].
- ▶ Precisely align the cooktop.

Information regarding surface mounting:

- ▶ make sure that the cooktop sealing tape is flat against the worktop.

Information regarding flush installation:

- ▶ make sure that the cooktop sealing tape is well sealed all the way round.

Height adjustment plates for flush installation (optional)

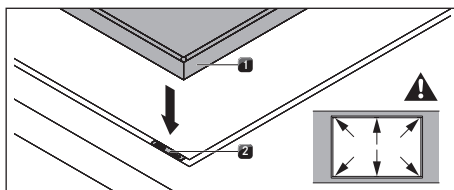

Fig. 10.19 Inserting height adjustment plates

- [1] Cooktop
- [2] Height adjustment plate

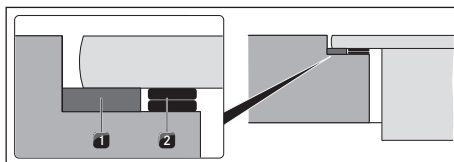

Fig. 10.20 Height adjustment plates

- [1] Sealing tape
- [2] Optional height adjustment plates

- The height adjustment plates are self-adhesive to prevent slipping during installation.
- ▶ If applicable, insert the height adjustment plates [2].
- ▶ Place the height adjustment plates next to the sealing tape [2].

10.6.5 Securing the cooktop

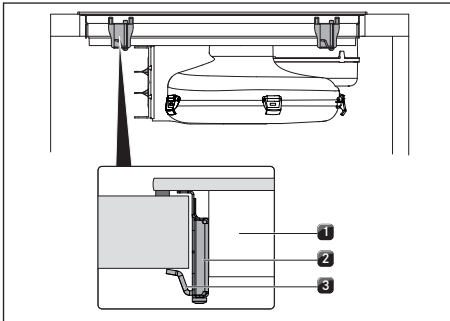

Fig. 10.21 Securing the cooktop in the middle

- [1] Cooktop
- [2] Mounting bracket
- [3] Fixing bracket

- ▶ Secure the cooktop to the worktop [1] with the fixing bracket [3] on the installation clamp [2].
- ▶ Tightening torque: max. 2.2 Nm.

10.6.6 Connecting the appliance to the duct system

- i** The duct system must be fitted to the appliance free of load and with the power supply switched off.
- i** For correct installation, the drawers of the floor unit must be shortened depending on the installation situation.
- i** When attaching the seals, ensure that an airtight seal is created with the connecting duct piece when the seals are compressed.

- ▶ Use only BORA Ecotube duct parts.
- ▶ Do not use flexible or fabric hoses.

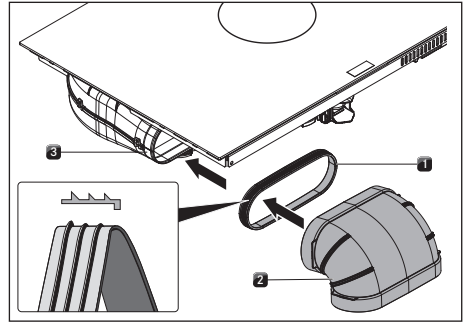

Fig. 10.22 Connecting the duct system

- [1] Seal
- [2] Duct part
- [3] Exhaust opening

- ▶ Pull the seal [1] onto the exhaust opening [3] on the appliance. To do this, the seal [1] will need to be stretched slightly.
- ▶ Push the duct part to be connected [2] with the coupling onto the exhaust opening [3] with the seal [1].
- ▶ Ensure that the seal [1] is not displaced.

10.7 Installing the recirculation model (PUXU, PURU) of the appliance

10.7.1 Recirculation of air from the kitchen unit

In the case of recirculation appliances, a return flow aperture of $\geq 500 \text{ cm}^2$ must be provided in the kitchen unit to guide the clean recirculated air out of the unit and back into the room.

The return flow aperture can be created above a shortened plinth. A slatted plinth with at least the minimum opening cross-section can also be used.

- i** A return flow aperture $\geq 500 \text{ cm}^2$ must be provided in the kitchen units.

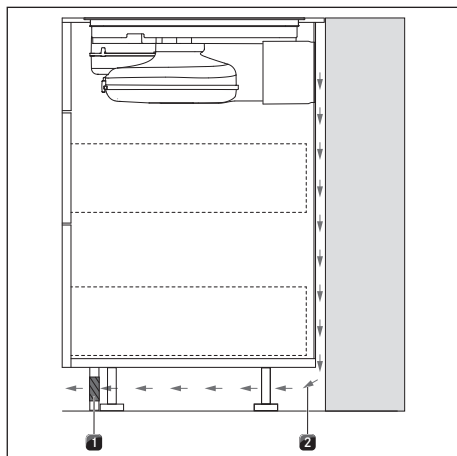

Fig. 10.23 Return flow aperture in the plinth area

- [1] Return flow aperture in the plinth (total cross-section of the aperture $\geq 500 \text{ cm}^2$)
- [2] Return flow of recirculated air

► Decrease the height of the plinth panel or create corresponding openings in the plinth.

10.7.2 Installation variants (A and B) for recirculation appliances

There are 2 installation variants for recirculation appliances PUXU and PURU: A and B

A: floor unit with continuous back panel

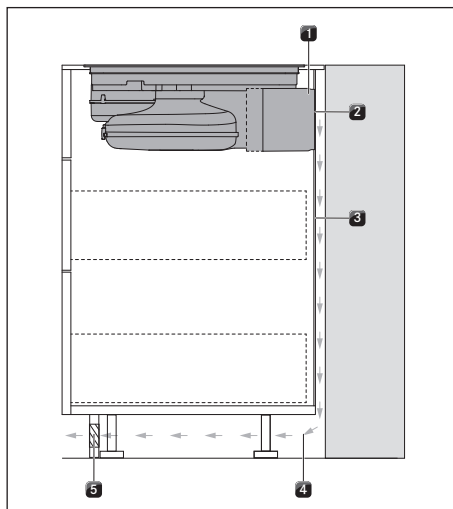

Fig. 10.24 Installation variant with continuous back panel

- [1] Air cleaning box
- [2] Connection with the back panel
- [3] Continuous back panel in the unit
- [4] Return flow of recirculated air
- [5] Return flow aperture

The recirculated air [4] is guided through the connection with the back wall [2] of the air cleaning box [1] directly behind the back panel of the unit [3]. The recirculated air goes back in to the room through the return flow aperture [5].

For installation purposes, this means that:

- No false floor is necessary below the cooktop.
- There must be a cut-out in the back panel.

B: floor unit with false floor under the cooktop

Fig. 10.25 Installation variant with false floor

- [1] Worktop
- [2] Air cleaning box
- [3] False floor
- [4] Back panel of unit
- [5] Return flow of recirculated air
- [6] Return flow aperture

The recirculated air [5] is blown into the free space between the worktop [1] and the false floor [3] (the air cleaning box [2] does not connect with the back panel). The recirculated air goes behind the rear panel of the unit [4] and through the return flow aperture [6] back into the room.

For installation purposes, this means that:

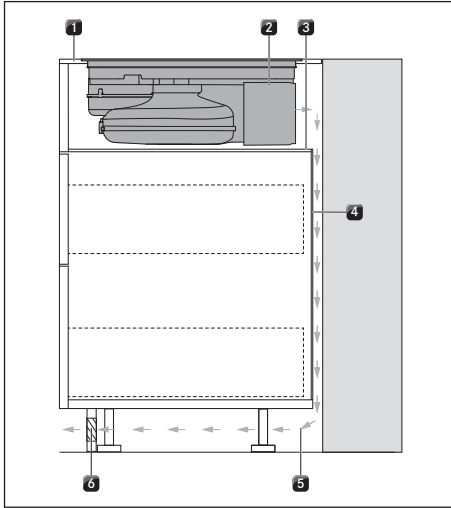
- a false floor is necessary below the cooktop.
- There does not need to be a cut-out in the back panel of the unit.

10.7.3 Preparing kitchen units for installation variant A (floor unit with continuous back panel)

- Cross bars on the kitchen unit in the area of the worktop cut-out may need to be removed.

- In the case of thin worktops, there must be a sufficiently rigid support plate on the unit.
- The floor unit must have a continuous back panel so that the recirculated air is not directed into the front furniture body compartment.
- There must be a cut-out in the back panel.
- A minimum clearance of 25 mm between the back panel of the unit and an adjacent kitchen unit or room wall must be observed for the return flow of the recirculation air.
- No false floor is necessary below the cooktop. If cable protection (false floor) is planned, the following must be taken into account:
 - it must be fitted in such a way that it can be removed for maintenance work.
 - To ensure sufficient cooktop ventilation, a minimum distance of 15 mm to the bottom edge of the cooktop is to be observed.
- The drawers and/or shelves in the floor unit must be removable.
- For correct installation, the drawers of the floor unit must be shortened depending on the installation situation.

10.7.4 Installation dimensions

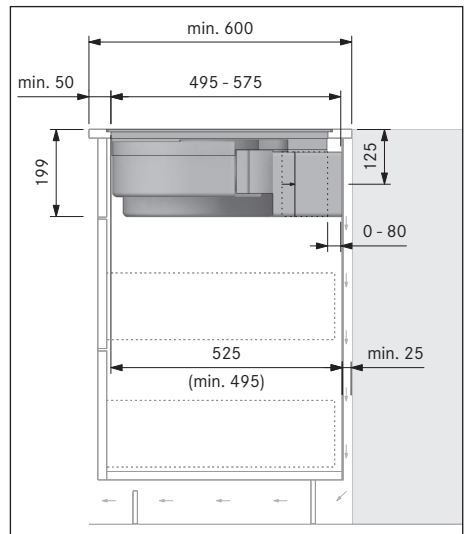

Fig. 10.26 Installation dimensions in the case of recirculated air, installation variant A

Adjusting the back panel of the unit

- ▶ Adapt the back panel according to the required installation dimensions.
- ▶ If necessary, move the back panel.
- ▶ If necessary, extend the height of the back panel so that the unit is closed to the front.

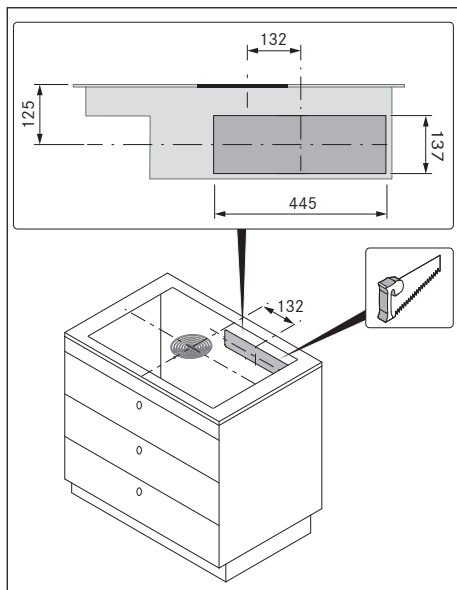

Fig. 10.27 Back panel cut-out

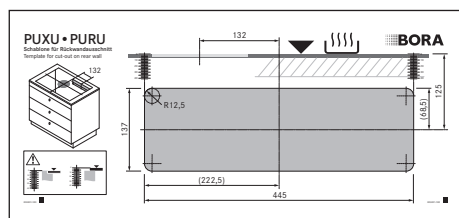

Fig. 10.28 Template for back panel cut-out

- ▶ Position the template on the back panel of the unit with the help of the markings and instructions.

- i Flush installation and surface installation must be taken into account when positioning the template.
 125 mm from the top edge of the cooktop to the middle of the cut-out.

- ▶ Draw the back panel cut-out.
- ▶ Saw out back panel cut-out.

10.7.5 Preparing kitchen units for installation variant B (floor unit with false floor under the cooktop)

- Cross bars on the kitchen unit in the area of the worktop cut-out may need to be removed.
- In the case of thin worktops, there must be a sufficiently rigid support plate on the unit.
- A false floor must be provided for under the cooktop:
 - it must be fitted in such a way that it can be removed for maintenance work.
 - To ensure sufficient cooktop ventilation, a minimum distance of 15 mm to the bottom edge of the cooktop is to be observed.
- The back panel of the unit must be flush with the false floor so that the recirculating air is not directed into the front of the unit.
- A minimum clearance of 25 mm between the back panel of the unit and an adjacent kitchen unit or room wall must be observed for the return flow of the recirculation air.
- The drawers and/or shelves in the floor unit must be removable.
- For correct installation, the drawers of the floor unit must be shortened depending on the installation situation.

10.7.6 Installation dimensions

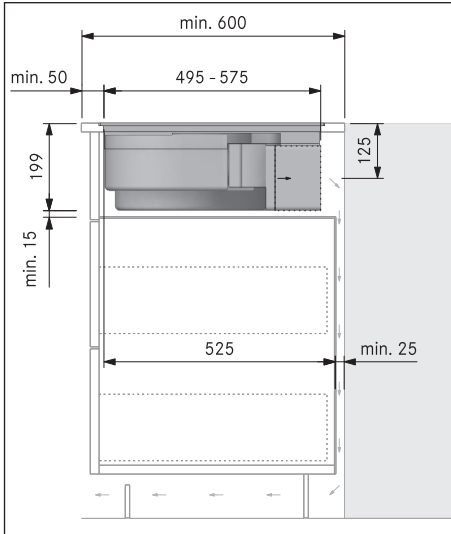

Fig. 10.29 Installation dimensions for recirculation installation variant B, depth of worktop 600 mm

Adjusting the back panel of the unit

- ▶ Adapt the back panel according to the required installation dimensions.
- ▶ If necessary, move the back panel.
- ▶ Adjust the height of the back panel to the false floor so that they are flush with one another.

10.7.7 Preparing the cooktop

Attaching the sealing tape

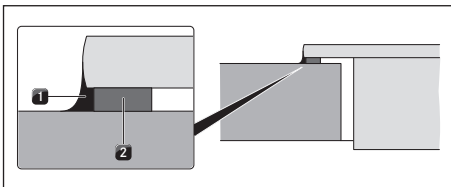

Fig. 10.30 Sealing tape in the case of surface mounting

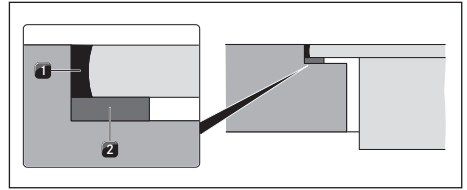

Fig. 10.31 Sealing tape in the case of flush installation

- [1] Black, heat-resistant silicone sealant
- [2] Sealing tape

- ▶ In the case of surface mounting, attach the enclosed sealing tape [2] around the outer edges of the underside of the cooktop. Do not leave any gaps.
- ▶ In the case of flush installation, attach the sealing tape [2] to the horizontal cutting edge in the worktop cut-out, even if you are sealing the cooktop with a silicone sealing compound [1] or similar.

Fitting the installation clamps

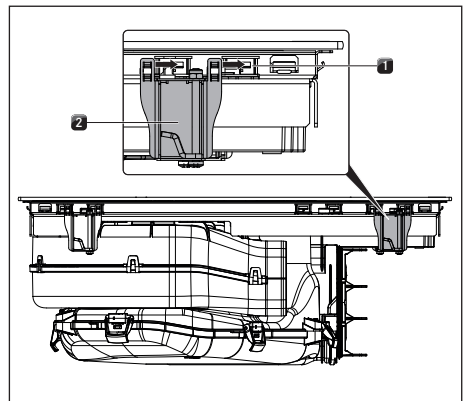

Fig. 10.32 Fitting the installation clamps

- [1] Retaining brackets
- [2] Installation clamps

i 2 installation clamps must be fitted to each side of the cooktop.

- ▶ Push 2 installation clamps [2] onto each side of the cooktop until they come to a stop in the retaining brackets [1] provided.

10.7.8 Extending the telescopic pull-out of the air cleaning box (PULBTA)

If the depth of the worktop exceeds 675 mm in installation variant A, the telescopic pull-out of the air cleaning box must be extended using the accessory PULBTA.

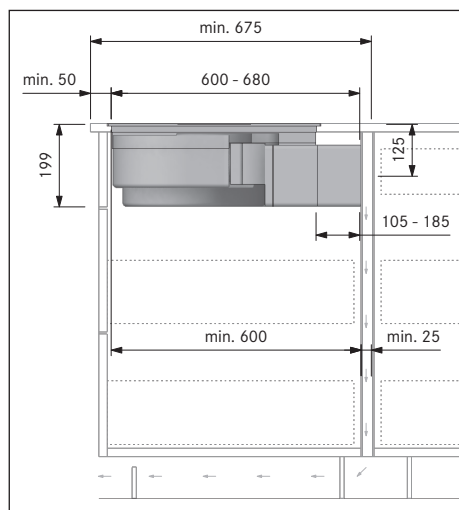

Fig. 10.33 Installation dimensions for recirculation installation variant A, depth of worktop 675 mm and over

- i** The telescopic pull-out is used to connect the duct to the back panel of the kitchen unit. This can be used to flexibly bridge the gap between the cooktop and the back panel of the kitchen unit (max. 80 mm). If necessary, the telescopic pull-out can be extended by a further 105 mm using the extension PULBTA (available as an accessory).

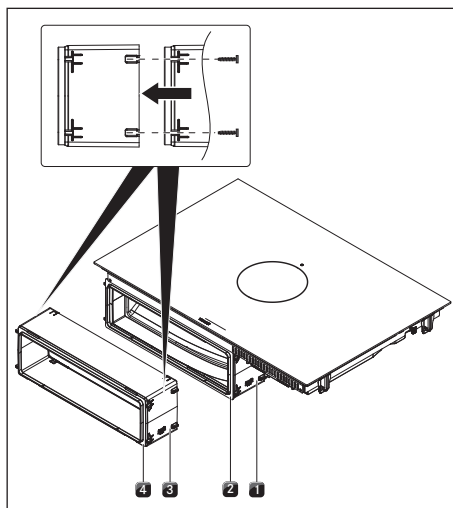

Fig. 10.34 Extending the telescopic pull-out.

- [1] Air cleaning box with telescopic pull-out
- [2] Telescopic pull-out adhesive tape
- [3] Telescopic pull-out extension PULBTA
- [4] Adhesive tape for telescopic pull-out extension PULBTA

- ▶ Remove the protective film from the adhesive tape [2] on the front of the telescopic pull-out [1].
- ▶ Attach the extension PULBTA [3] (available as an accessory including screws for attachment) to the telescopic pull-out [1].
- ▶ Remove the protective film from the adhesive tape [4] on the front of the extension PULBTA [3].

10.7.9 Inserting the cooktop

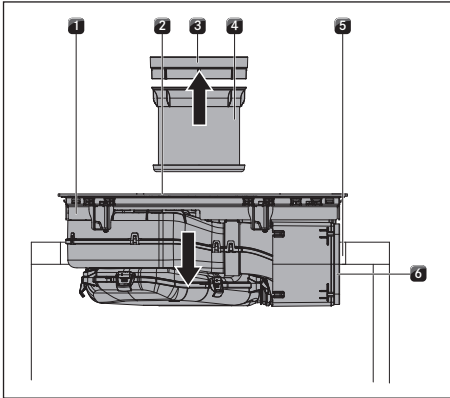

Fig. 10.35 Positioning the cooktop in the centre

- [1] Cooktop
- [2] Inlet opening
- [3] Air inlet nozzle
- [4] Stainless steel grease filter
- [5] Worktop cut-out
- [6] Adhesive tape

- ▶ Before inserting the cooktop, remove the air inlet nozzle [3] and the stainless steel grease filter [4].
- ▶ Remove the protective film from the adhesive tape [6] on the front of the telescopic pull-out.
- ▶ Use the inlet opening [2] as a handle during insertion.
- ▶ Keep the cooktop [1] straight as you lift it into the worktop cut-out [5].
- ▶ Insert the cooktop [1] into the centre of the worktop cut-out [5].
- ▶ Precisely align the cooktop.

- ▶ When aligning the cooktop, ensure that the holding clamps hold the cooktop in the worktop.

Information regarding surface mounting:

- ▶ make sure that the cooktop sealing tape is flat against the worktop.

Information regarding flush installation:

- ▶ make sure that the cooktop sealing tape is well sealed all the way round.

Height adjustment plates for flush installation (optional)

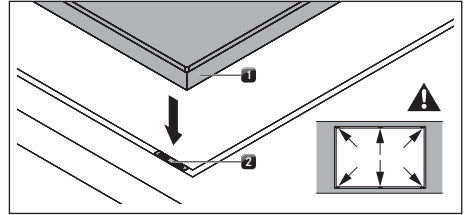

Fig. 10.36 Height adjustment plates

- [1] Cooktop
- [2] Height adjustment plate

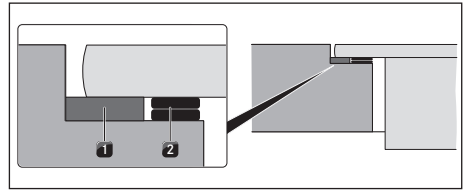

Fig. 10.37 Height adjustment plates

- [1] Sealing tape
- [2] Optional height adjustment plates

- The height adjustment plates are self-adhesive to prevent slipping during installation.
- ▶ If applicable, insert the height adjustment plates [2].
- ▶ Place the height adjustment plates next to the sealing tape [2].

10.7.10 Securing the cooktop

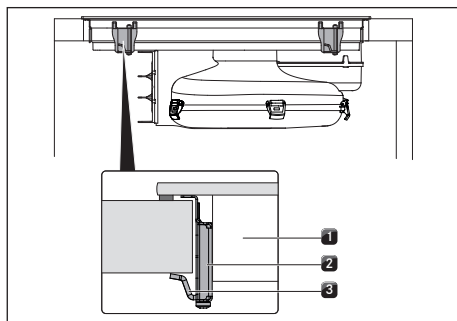

Fig. 10.38 Securing the cooktop

- [1] Cooktop
- [2] Mounting bracket
- [3] Fixing bracket

- ▶ Secure the cooktop to the worktop [1] with the fixing bracket [3] on the installation clamp [2].
- Tightening torque: max. 2 Nm

10.7.11 Making a connection with the back panel (only in installation variant A)

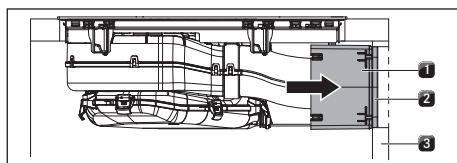

Fig. 10.39 Connection with the back panel

- [1] Telescopic pull-out
- [2] Adhesive tape
- [3] Back panel of unit

- ▶ Push the telescopic pull-out [1] until it is tight up against the back panel of the unit [3].
- With the telescopic pull-out the distance to the back panel of the unit can be flexibly bridged.
- ▶ Check that the telescopic pull-out [1] fits accurately, is flush with the cut-out on the back panel of the unit [3] and closes it off.
- ▶ Secure the telescopic pull-out [1] to the back panel of the unit [3] using the adhesive tape [2]

10.7.12 Inserting the activated charcoal filter

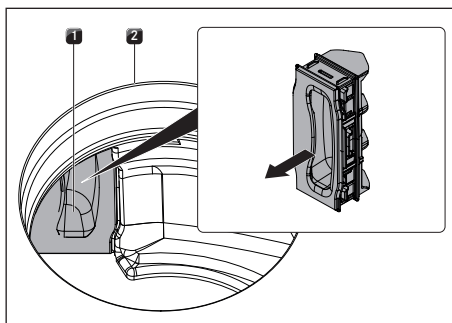

Fig. 10.40 Remove the filter replacement cover

- [1] Filter replacement cover
- [2] Inlet opening

- ▶ Inside the inlet opening [2] pull the filter replacement cover [1] out through the opening in the filter housing.

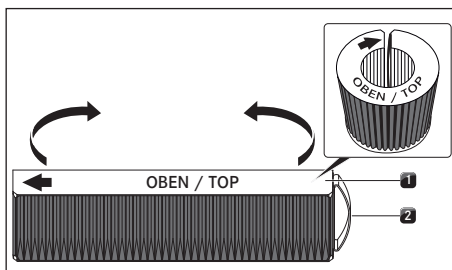

Fig. 10.41 Activated charcoal filter

- [1] Activated charcoal filter
- [2] Grip strap

- ▶ Remove the packaging from the activated charcoal filter [1].
- ▶ Position the activated charcoal filter correctly with the help of the printed symbols (arrow left, grip strap [2] right).
- ▶ Hold the activated charcoal filter at both ends.
- ▶ Bend the activated charcoal filter into a cylindrical shape so that both ends of the filter are opposite each other.

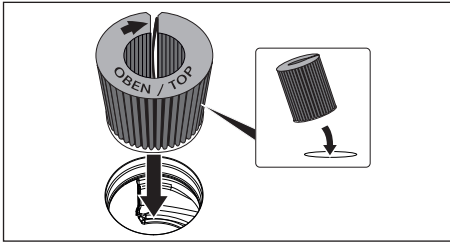

Fig. 10.42 Inserting the activated charcoal filter through the vent opening

- ▶ Tilt the activated charcoal filter towards you slightly and insert it through the inlet opening.
- ▶ Guide the left end of the filter into the opening in the filter housing.

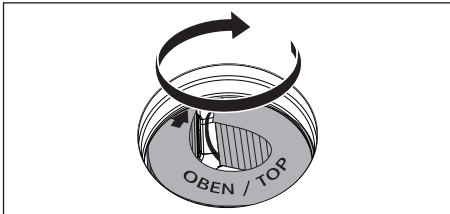

Fig. 10.43 Placing the activated charcoal filter in the end position

- ▶ Push the activated charcoal filter into the filter housing until it will go no further (to do this, you can place one finger between the slats and gradually push the filter into the housing).
- The end position of the activated charcoal filter is reached when the filter has been fully pushed inside the filter housing.

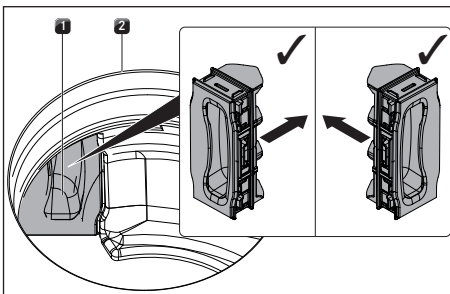

Fig. 10.44 Inserting the filter replacement cover

- [1] Filter replacement cover
- [2] Inlet opening

- ▶ Inside the inlet opening push the filter replacement cover until it comes to a stop in the filter housing opening.
- ▶ Check that the filter replacement cover is positioned correctly.

10.8 Connecting the power supply

- ▶ Observe all safety and warning information (see "2 Safety").
- ▶ Observe all national and regional laws and regulations as well as the supplementary regulations of the local utility companies.

i The appliances may only be connected to the mains power supply by certified specialists. The specialist also assumes responsibility for the proper installation and commissioning.

i Connections via plug-in contacts (Schuko plugs) are not permitted.

i 1-phase connection The appliance complies with the requirements of IEC 61000-3-12.

i With the optional Home In accessory module PUHIM (12 V/35 mA), upgrade to an interface for external devices (e.g. window contact switch) is possible.

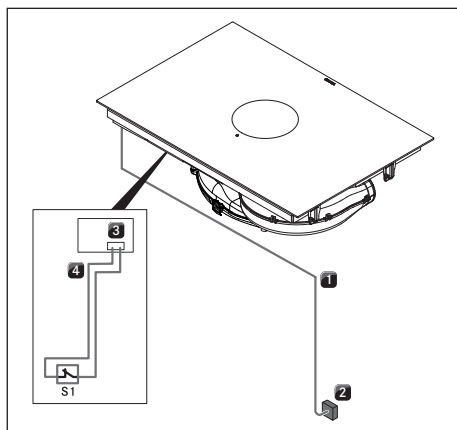

Fig. 10.45 Connection diagram with optional Home In module

- [1] Cooktop and cooktop extractor power supply cable
- [2] Power supply
- [3] Home In module PUHIM (not included in scope of delivery)
- [4] Home In connection cable
- [S1] External switch contact

- ▶ Switch off the main switch/automatic circuit breaker before connecting the cooktop.
- ▶ Secure the main switch/automatic circuit breaker against being switched back on without permission.
- ▶ Make sure the power to the appliance is disconnected.
- ▶ Connect the cooktop exclusively via a fixed connection to an H 05 VV-F power supply cable with corresponding minimum cross-section (see Table “Fuse protection and minimum cross-section”).

Connection	Fuse protection	Minimum cross-section
Three-phase connection	3 x 16 A	2.5 mm ²
Two-phase connection	2 x 16 A	2.5 mm ²
One-phase connection	1 x 32 A	4 mm ²

Tab. 10.2 Fuse protection and minimum cross-section

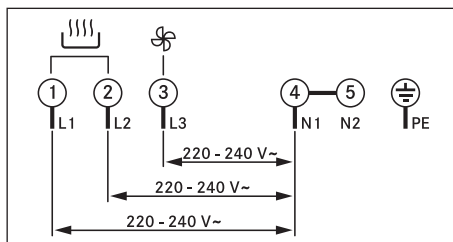

Fig. 10.46 Connection diagram - three-phase connection

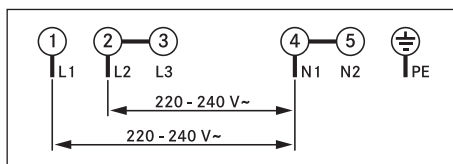

Fig. 10.47 Connection diagram - two-phase connection

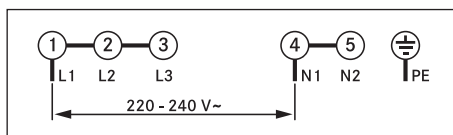

Fig. 10.48 Connection diagram - one-phase connection

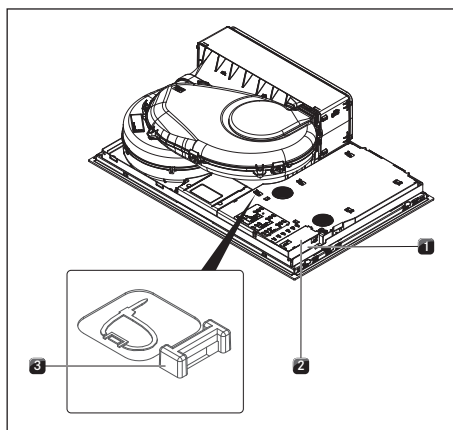

Fig. 10.49 Electrical connections of the cooktop

- [1] Power supply
- [2] Power supply cover
- [3] Mounting eyes

- ▶ Connect the power supply cable to the power supply [1] of the appliance in accordance with the relevant connection diagram (see Fig. "Connection diagram" or underside of appliance).
- ▶ For a one-phase or two-phase connection, connect the relevant contacts using the bridge provided (in scope of delivery).
- ▶ Secure the connection cable with the strain relief clamp (in scope of delivery).
- ▶ Close the power supply housing with the power supply cover [2] (in scope of delivery).
- ▶ Lay the connection cable along the mounting eyes [3] with the help of the cable ties (in scope of delivery).
- ▶ Ensure that the cable is not trapped or damaged and is not able to come into contact with any hot areas on the cooktop.
- ▶ Check that installation has been carried out correctly.

10.9 Initial operation

- i** During initial operation some basic settings (basic configuration) must be applied using the dealer and service menu.

10.9.1 Dealer and service menu

- i** The dealer and service menu can be called up up to 2 minutes after the appliance has been connected to the power supply.
- i** The system adopts and saves the settings made when you exit the corresponding menu item.
- i** Below you will find explanations on how to use the menu and a description of the most important menu items.

Dealer and service menu overview

Menu item/Description/Selection area	Factory setting
B Extraction system (exhaust air/recirculation system)	Recirculation
C Power management	☐
D Demo mode	Off

Tab. 10.3 Menu overview

Calling up the dealer and service menu

- ▶ Connect the appliance to the power supply.

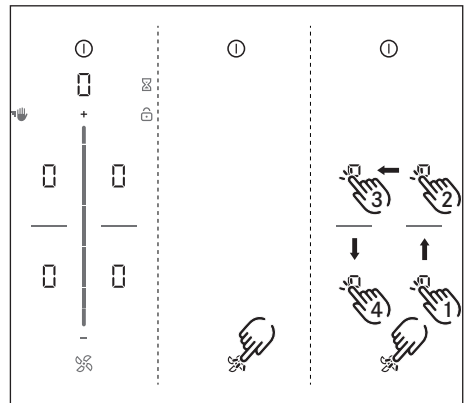





Fig. 10.50 Calling up the dealer and service menu

- The standard display appears and the fan symbol pulses for 2 minutes.
- ▶ Long press on the fan button .
- 4 input points  are shown.
- ▶ Keep the fan button  pressed and at the same time press the input points  in the specified order.
- Menu item B is displayed.

Menu item B: Extraction system configuration

The extraction system must be configured. There are two operating modes to choose from:

- Operating mode 1: recirculation system (factory setting)
- Operating mode 2: exhaust air system

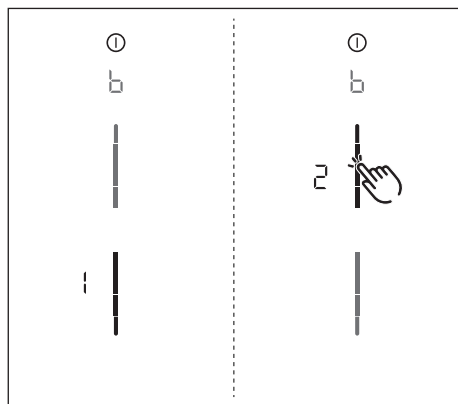

Fig. 10.51 Display Menu item B: Configuring the extraction system

- ▶ Select the corresponding operating mode (tap the corresponding segment on the slider).
- ▶ Confirm and save the setting by moving to the next menu item (tap the multi-function display/indicator b).

Menu item C: Power management

The total appliance power can be reduced if the required electrical power cannot be provided at the installation site.

- i** The cooking zone power restrictions automatically implemented by the appliance are determined according to the total power set.

There are three operating modes to choose from:

Power management	Connection	Maximum power consumption	Fuse protection
C3	three-phase	7.6 kW	3 x 16 A
C3	two-phase	7.6 kW	2 x 16 A
C3	single-phase	7.6 kW	1 x 32 A
C2	single-phase	4.4 kW	1 x 20 A
C1	single-phase	3.6 kW	1 x 16 A

Tab. 10.4 Power management

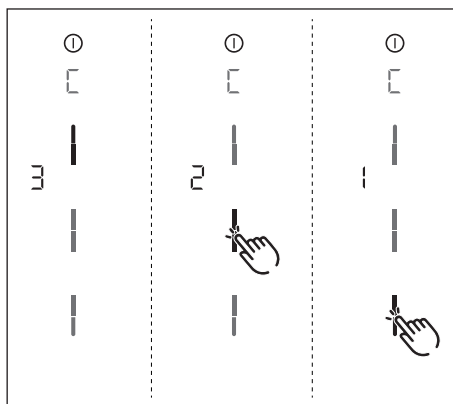

Fig. 10.52 Display menu item C: Power management

- ▶ Select the corresponding operating mode (tap the corresponding segment on the slider).
- ▶ Confirm and save the setting by moving to the next menu item (tap the multi-function display/indicator c).

Menu item D: Demo mode

The appliance can be set to demo mode, which includes all operating functions, but the heating function of the cooktops is deactivated.

- i** Pan size recognition is deactivated in demo mode.

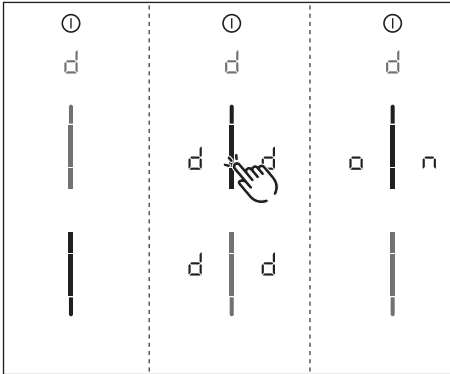

Fig. 10.53 Display Menu item D: Demo mode

- ▶ Tap the top slider segment.
- The demo mode symbol **d** is displayed on all cooking zones for one second.
- **d** is displayed.
- ▶ Confirm and save the setting by moving to the next menu item (tap the multi-function display/indicator **d**).

Closing the dealer and service menu

When you have been through all of the basic configuration menu items:

- ▶ long press on the multi-function display.
- The standard display appears.

10.9.2 Function test

- ▶ Carry out a thorough function test on all appliances.
- ▶ In the event of error messages, see the “Troubleshooting” chapter (see “9 Troubleshooting”).

10.10 Sealing the appliance

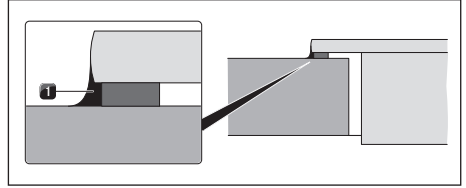

Fig. 10.54 Silicone sealant for surface mounting

- [1] Black, heat-resistant silicone sealant

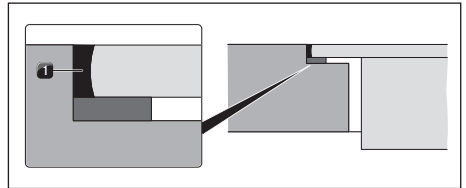

Fig. 10.55 Silicone sealant for flush installation

- [1] Black, heat-resistant silicone sealant

- ▶ Once all of the installation work is complete, seal the appliance with black, heat-resistant silicone sealant [1].
- ▶ Make sure that no silicone sealant gets under the cooktop.

10.11 Handover to user

Once installation is complete:

- ▶ Explain the main functions to the user.
- ▶ Explain all safety-related aspects of operation and handling to the user.
- ▶ Provide the user with the accessories and operating and installation instructions, which are to be kept in a safe place.

11 Decommissioning, disassembly and disposal

- ▶ Observe all safety and warning information (see “2 Safety”).
- ▶ Follow the enclosed manufacturer's information.

11.1 Decommissioning

Decommissioning refers to ultimate decommissioning and disassembly. Following decommissioning, the appliance can either be installed in another unit, sold on privately or disposed of.

- i** The electricity and gas connections may only be disconnected and cut off by certified specialists.
- ▶ Switch the appliance off before decommissioning (see “6 Functions and operation”).
- ▶ Disconnect the appliance from the power supply.

11.2 Disassembly

To be removed, the appliance must be accessible for disassembly and disconnected from the power supply.

- ▶ Remove the appliance fastenings.
- ▶ Remove the silicone seals.
- ▶ Lift the appliance up and out through the top of the worktop.
- ▶ Remove any other accessories.
- ▶ Dispose of the old appliance and any soiled accessories as described under “Environmentally-friendly disposal”.

11.3 Environmentally-friendly disposal

Disposal of transport packaging

- i** The packaging protects the appliance from damage during transport. The packaging materials have been selected taking into account the environment and their disposal and are therefore recyclable.

Recycling the packaging saves raw materials and reduces waste. Your specialist retailer will take the packaging back.

- ▶ Give the packaging to your specialist retailer or
- ▶ dispose of the packaging correctly observing regional regulations.

Disposal of accessories

- ▶ Dispose of unnecessary or used accessories (activated charcoal filters, etc.) accordingly taking into account the regional regulations.

Disposal of the old appliance



Electrical appliances with this mark must not be disposed of in the household waste at the end of their service life. They must be disposed of at a collection point for the recycling of electrical or electronic appliances. Information on this can be obtained from the city or local councils.

Waste electrical and electronic appliances often still contain valuable materials. However, they also contain harmful substances that were necessary to make them work and ensure their safety. If placed in the household waste or handled incorrectly, they may harm human health and damage the environment.

- ▶ Never dispose of your old appliance in the household waste.
- ▶ Take the appliance to a regional collection point for the return and further processing of electrical and electronic components and other materials.

12 Warranty, technical service, spare parts, accessories

- Observe all safety and warning information (see “2 Safety”).

12.1 BORA manufacturer's warranty

BORA provides its end customers with a 2-year manufacturer's warranty for its products. The end customer is entitled to this warranty in addition to the statutory claims for defects against the sellers of our products.

The manufacturer's warranty applies to the BORA products listed here that are sold by authorised BORA retailers or salespeople trained by BORA and are installed in the European Union (excluding overseas territories), Switzerland, Liechtenstein, Ukraine, Russia, Norway, Serbia, Israel, the UK, Iceland, India, Australia and New Zealand, with the exception of products referred to by BORA as universal products or accessories:

- Cooktops
- Cooktop extractor systems
- Fans

The manufacturer's warranty starts as soon as the BORA product is handed over to the end customer and is valid for 2 years. Registering on www.mybora.com enables the manufacturer's warranty to be extended to 3 years.

The manufacturer's warranty requires expert installation of the BORA products by an authorised BORA retailer (in accordance with the valid BORA ventilation handbook and operating instructions at the time of installation). During use, the end customer is to adhere to the specifications and instructions in the operating manual.

When filing a warranty claim, BORA must be directly notified of the fault and the receipt must be presented. Alternatively, proof of purchase can be provided by registering on www.mybora.com. BORA guarantees that all BORA products are free from material and production defects. The defect must exist prior to delivery of the product to the end customer. Filing a warranty claim does not interrupt the warranty period, nor shall the period start anew.

BORA will correct defects in BORA products at its own discretion by repairing or replacing the product. All costs for the correction of defects under the manufacturer's warranty shall be assumed by BORA. Expressly not covered by the BORA manufacturer's warranty are:

- BORA products that were not sold by authorised BORA retailers or salespersons trained by BORA
- Damage caused by non-adherence to the operating instructions (including product care and cleaning). This represents improper use.
- Damage caused by normal use, e.g. traces of usage on the cooktop
- Damage caused by external influences (such as transport damage, ingress of condensation, damage caused by the elements such as a lightning strike)
- Damage caused by repairs or attempts to repair not carried out by BORA or persons authorised by BORA
- Damage to the glass ceramic
- Injury caused by electrical voltage fluctuations
- Secondary damage or claims for damages beyond the defect
- Damage to plastic parts

Legal claims, particularly statutory claims for defects or product liability are not limited by the warranty and can be asserted free of charge.

If a defect is not covered by the manufacturer's warranty, a claim may be made against the BORA Technical Service.

BORA shall not assume the resulting costs.

The laws of the Federal Republic of Germany apply to these warranty conditions.

You can contact us at:

BORA Vertriebs GmbH & Co KG, Innstraße 1, 6342 Niederndorf, Austria

- Telephone: +49 800 7890 0987
Monday to Thursday from 08:00–18:00 and
Friday from 08:00–17:00
- Email: info@bora.com

12.1.1 Warranty extension

You can extend the warranty by registering on www.bora.com/registration.

12.2 Service

BORA Service:

see reverse side of the operating and assembly instructions



- ▶ In the case of faults you cannot fix yourself, contact your BORA specialised retailer or the BORA Service Team.

The BORA Service Team will require the type designation and serial number of your appliance (FD number).

You can find both details on the nameplate on the warranty form as well as on the bottom of the appliance.

12.3 Spare parts

- ▶ Only use original spare parts for repairs.
- ▶ Repairs may only be carried out by the BORA Service Team.

i Spare parts can be obtained from your BORA dealer, the BORA online service website at www.bora.com/service or by calling the service number provided.

12.4 Accessories

Accessories	PUXA	PUXU	PURA	PURU
Activated charcoal filter PUAKE		✓		✓
Stainless steel grease filter PUEF	✓	✓	✓	✓
Air inlet nozzle PUXED	✓	✓		
Air inlet nozzle black PUED			✓	✓
Air inlet nozzle greige PUEDG			✓	✓
Air inlet nozzle red PUEDR			✓	✓
Air inlet nozzle jade green PUEDJ			✓	✓
Air inlet nozzle orange PUEDO			✓	✓
Air inlet nozzle blue PUEDB			✓	✓
Air inlet nozzle light grey PUEDL			✓	✓
Air inlet nozzle sun yellow PUEDS			✓	✓
Trim USL515	✓	✓	✓	✓
Trim All Black USL515AB	✓	✓	✓	✓
Cooktop frame BKR830	✓	✓		
Cooktop frame BKR760			✓	✓
Glass ceramic scraper UGS	✓	✓	✓	✓
Home In module PUHIM	✓		✓	
Window contact switch UFKS	✓		✓	
Air cleaning box PULB (for conversion from exhaust air to recirculation)	✓		✓	
Extension for air cleaning box telescopic pull-out PULBTA		✓		✓

Fig. 11.1 Accessories for X Pure, Pure

Operating and installation instructions:

Original

Translation

Manufacturer: BORA Vertriebs GmbH & Co KG

The distribution and duplication of this document, as well as the use and disclosure of its contents are prohibited unless expressly authorised.

These operating and installation instructions have been drawn up with the greatest of care. But it cannot be ruled out that subsequent technical modifications have not yet been incorporated or the relevant content has not yet been adapted. Please accept our apologies in this eventuality. An updated version can be requested from the BORA Service Team. Subject to printing errors and mistakes.

© BORA Vertriebs GmbH & Co KG

All rights reserved.

D

BORA Lüftungstechnik GmbH
Rosenheimer Str. 33
83064 Raubling
Germany
T +49 (0) 8035 / 9840-0
F +49 (0) 8035 / 9840-300
info@bora.com
www.bora.com

A

BORA Vertriebs GmbH & Co KG
Innstraße 1
6342 Niederndorf
Austria
T +43 (0) 5373 / 62250-0
F +43 (0) 5373 / 62250-90
mail@bora.com
www.bora.com

INT

BORA Holding GmbH
Innstraße 1
6342 Niederndorf
Austria
T +43 (0) 5373 / 62250-0
F +43 (0) 5373 / 62250-90
mail@bora.com
www.bora.com

AU NZ

BORA APAC Pty Ltd
100 Victoria Road
Drummoyne NSW 2047
Australia
T +61 2 9719 2350
F +61 2 8076 3514
info@boraapac.com.au
www.bora-australia.com.au

 **+800 7890 0987**

